



ENGLISH ROSE®

DESIGNED FOR LIVING



PRICE LIST

JULY 2018 RETAIL PRICES INCLUDING VAT

THE KITCHEN COLLECTION



ENGLISH ROSE®

DESIGNED FOR LIVING

We hope that you have enjoyed selecting your ideal kitchen from the extensive range shown in our brochure. Now that you have decided on your style of kitchen, please use this price list to help you add all the essential ingredients together to ensure every last detail has been catered for.

HOW TO ORDER

- Please follow these simple steps to ensure that you order your English Rose kitchen correctly.
- Choose your door style - e.g. *Regent Ivory*
 - Choose your cabinet colour - e.g. *Ivory*
 - Choose your accessory colour (if different to cabinet colour)
 - Choose your handle suite - e.g. *Handle suite 708* (see page 68 for handles)
 - Choose your worktop - e.g. *40mm Black Brazil* (see page 74 for worktops)
 - To ensure we can process your order efficiently, please provide full details of the delivery address (including full post code and contact telephone number) and details of restricted access.

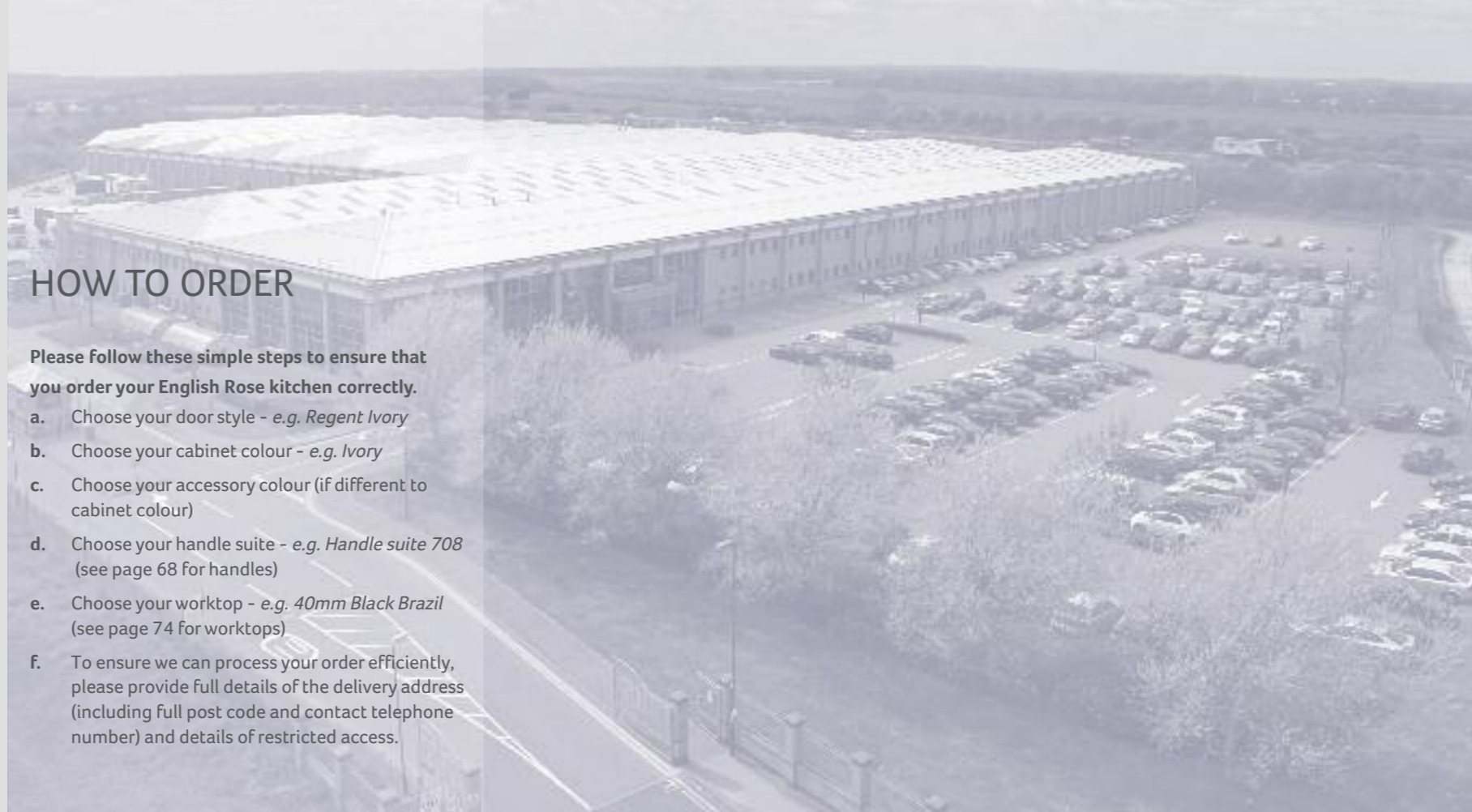

CONTENTS

Your kitchen - At a Glance	4
Painted Collection	6
Painted Order Codes	7
Price Group 0A	8
Price Group 0B	14
Price Group 1	20
Price Group 2	27
Price Group 3	34
Price Group 4	42
Price Group 5	49
Painted Open Units	56
Fascia Matrix	57
Feature Mantel	58
Working Mantel	59
Drawer Systems	60
Square Section Planning Guidelines	61
Glazed Door Designs	62
Oak Drawer Dividers	62
Metal Drawer Dividers	63
Lighting	64
Functional Accessories	66
Waste Bins	67
Kesseböhmer Wire Accessories	67
Handles	68
Sinks	70
Taps	72
Worktops	74
Worktops - Standard	76
Worktops - Curved	77
Worktop Planning Guidelines	78
Cabinet Colours	79
English Rose 'Contact' - Handle-less Kitchens	80
Technical Specifications	84

PRICE GROUPS

English Rose kitchens are priced within 7 affordable price groups - as indicated by the colour codes within this price list.

PRICE GROUP 0A	PRICE GROUP 0B	PRICE GROUP 1	PRICE GROUP 2	PRICE GROUP 3	PRICE GROUP 4	PRICE GROUP 5
Contemporary <ul style="list-style-type: none"> • Driftwood • Lissa Oak • White Avola • Brown Grey Avola • Sand Oak 	Contemporary <ul style="list-style-type: none"> • New England Oak • White Oak Zest <ul style="list-style-type: none"> • Gloss White • Gloss Ivory • Gloss Cashmere 	Ivory Prelude Shaker <ul style="list-style-type: none"> • Ivory • Lissa Oak • Sand Oak White Satin Moda White <ul style="list-style-type: none"> • White • Ivory • Cashmere • Light Grey Grooved Ivory Regent Ivory	Logica <ul style="list-style-type: none"> • Gloss White • Gloss Stone • Gloss Ivory • Gloss Cashmere • Gloss Light Grey • Gloss Grey Shaker Painted* Opaco Painted* Abbey (available September 2018)	Shaker <ul style="list-style-type: none"> • Gloss Stone Davenport Platinum White Davenport Painted* Fusion <ul style="list-style-type: none"> • Gloss White • Gloss Grey • Gloss Ivory • Gloss Anthracite • Gloss Cashmere • Gloss Light Grey • Gloss Limestone Fusion Painted* Classic Painted* Concept Painted*	Shaker <ul style="list-style-type: none"> • Lissa Oak Wood • Sand Oak Wood Fusion Shaker <ul style="list-style-type: none"> • Gloss White 	Shaker Wood Painted* Heritage Painted* Richmond Painted* Stately Shaker Painted*

* Shaker Painted, Classic Painted, Davenport Painted, Fusion Painted, Shaker Wood Painted, Heritage Painted, Richmond Painted, Concept Painted, Opaco Painted and Stately Painted Shaker are available in the following colours: Light Blue, Green, Oyster, Sage Grey, White, Ivory, Light Grey, Cashmere, Hickory, Oxford Blue, Limestone, Sandstone, Anthracite and Steel Blue.



DEPOSIT GUARANTEE SCHEME

English Rose Kitchens' Deposit Guarantee Scheme offers you peace of mind and certainty when you purchase an English Rose Kitchen from any of our approved English Rose Kitchens Retailers. Should the retailer cease to trade before we have delivered your kitchen then we guarantee to supply your English Rose Kitchen furniture at the current manufacturer's recommended retail price list less the deposit paid provided that the amount paid to the retailer does not exceed 50% of the manufacturer's recommended retail price.

FOR COMPLETE PEACE OF MIND



*Please ask your retailer for further details



The mark of responsible forestry



AT A GLANCE - ABOUT YOUR NEW KITCHEN, INSIDE & OUT

For easy reference we have listed all the details you may need to know about your chosen kitchen. We show you what it is made from, what co-ordinating accessories are available and also provide you with our internal cabinet recommendations to make sure your new kitchen is just as stunning on the inside as it is on the outside.

English Rose units are supplied with a soft-close adjustable hinges as standard. Additional hinges can be purchased, please refer to page 66.

TOP TIP It's easy to underestimate the amount of cornice and pelmet required. Please double check that before placing your order you have the right quantity.

Kitchen Range	Material Description	Order Code	Lead Time	Recommended Cabinet Colour	Cornice/Pelmet Type	Plinth	Mantel	Canopy	Curved Units	Tall Units		
0A	Contemporary Driftwood	Melamine faced particle board with PVC edging	MDW	6-11 Days†	Platinum White	18mm MFC	MFC	NO	NO	NO	NO	
	Contemporary Lissa Oak	Melamine faced particle board with PVC edging	MLH	6-11 Days†	Lissa Oak	18mm MFC	MFC	NO	NO	NO	NO	
	Contemporary White Avola	Melamine faced particle board with PVC edging	MAW	6-11 Days†	White	18mm MFC	MFC	NO	NO	NO	NO	
	Contemporary Brown Grey Avola	Melamine faced particle board with PVC edging	MAG	6-11 Days†	Ivory	18mm MFC	MFC	NO	NO	NO	NO	
	Contemporary Sand Oak	Melamine faced particle board with PVC edging	MSO	6-11 Days†	Sand Oak	18mm MFC	MFC	NO	NO	NO	NO	
0B	Contemporary New England Oak	Melamine faced particle board with PVC edging	MHO	6-11 Days†	Ivory/White	18mm MFC	MFC	NO	NO	NO	NO	
	Contemporary White Oak	Melamine faced particle board with PVC edging	MWO	6-11 Days†	White	18mm MFC	MFC	NO	NO	NO	NO	
	Zest Gloss White	Gloss Melamine faced particle board with PVC edging	MWG	6-11 Days†	Gloss White	18mm MFC	MFC/Gloss	NO	NO	NO	NO	
	Zest Gloss Ivory	Gloss Melamine faced particle board with PVC edging	MIG	6-11 Days†	Gloss Ivory	18mm MFC	MFC/Gloss	NO	NO	NO	NO	
	Zest Gloss Cashmere	Gloss Melamine faced particle board with PVC edging	MCG	6-11 Days†	Gloss Cashmere	18mm MFC	MFC/Gloss	NO	NO	NO	NO	
1	Ivory Prelude	PVC foil laminated on MDF	SVY	6-11 Days†	Ivory	Modern/Traditional	MFC	YES	YES	YES	YES	
	Shaker Ivory	Laminated MDF frame and centre panel	SIV	6-11 Days†	Ivory	Modern/Traditional	MFC/Foil	YES	NO	NO	YES	
	Shaker Lissa Oak	Laminated MDF frame and centre panel	SLA	6-11 Days†	Lissa Oak	Modern/Traditional	MFC	YES	NO	YES	YES	
	Shaker Sand Oak	Laminated MDF frame with veneered centre panel	SSF	6-11 Days†	Sand Oak	Modern/Traditional	MFC	YES	NO	YES	YES	
	Regent Ivory	PVC foil laminated on MDF	RVY	6-11 Days†	Platinum White	Modern/Traditional	MFC	NO	YES	NO	YES	
	White Satin	PVC foil laminated on MDF	FWH	6-11 Days†	Platinum White	Modern	MFC/PVC	NO	NO	YES	YES	
	Moda White	PVC foil laminated on MDF frame and centre panel	KTE	6-11 Days†	Platinum White	Modern	MFC/PVC	NO	NO	NO	YES	
	Moda Ivory	PVC foil laminated on MDF frame and centre panel	KVR	6-11 Days†	Ivory	Modern	MFC/PVC	NO	NO	NO	YES	
	Moda Cashmere	PVC foil laminated on MDF frame and centre panel	KAS	6-11 Days†	Matt Cashmere	Modern	MFC/PVC	NO	NO	NO	YES	
	Moda Light Grey	PVC foil laminated on MDF frame and centre panel	KRY	6-11 Days†	Aluminium	Modern	MFC/PVC	NO	NO	NO	YES	
Grooved Ivory	PVC foil laminated on MDF	OVP	6-11 Days†	Ivory	Modern/Traditional	MFC	NO	YES	NO	YES		
2	Shaker Painted (all colours)	Laminated MDF frame and centre panel painted	•	3-4 Weeks	Lissa Oak/Ivory	Modern/Traditional	MFC/Painted	YES	NO	YES	YES	
	Logica Gloss White	PVC foil laminated on MDF	GWS	6-11 Days†	Gloss White	Modern/Traditional	MFC/PVC	NO	NO	YES	YES	
	Logica Gloss Stone	PVC foil laminated on MDF	GSS	6-11 Days†	Gloss Stone	Modern/Traditional	MFC/PVC	NO	NO	YES	YES	
	Logica Gloss Ivory	PVC foil laminated on MDF	GIV	6-11 Days†	Gloss Ivory	Modern	MFC/PVC	NO	NO	YES	YES	
	Logica Gloss Grey	PVC foil laminated on MDF	GGY	6-11 Days†	Aluminium	Modern	MFC/PVC	NO	NO	YES	YES	
	Logica Gloss Light Grey	PVC foil laminated on MDF	GLY	6-11 Days†	Aluminium	Modern	MFC/PVC	NO	NO	YES	YES	
	Logica Gloss Cashmere	PVC foil laminated on MDF	GCS	6-11 Days†	Gloss Cashmere	Modern	MFC/PVC	NO	NO	YES	YES	
	Abbey (available September 2018)	PVC foil laminated on MDF	BSL	6-11 Days†	Aluminium	Modern/Traditional	MFC/PVC	NO	NO	NO	YES	
	Opaco Painted (all colours)	Painted finish on MDF	•	3-4 Weeks	Lissa Oak/Ivory	Modern/Traditional	MFC/Painted	YES	YES	YES	YES	
	3	Davenport Platinum White	Painted finish on MDF	PWH	3-4 Weeks	Platinum White	Traditional	MFC/Painted	YES	YES	YES	YES
Davenport Painted (all colours excl. white)		Painted finish on MDF	•	3-4 Weeks	Lissa Oak/Ivory	Traditional	MFC/Painted	YES	YES	YES	YES	
Shaker Gloss Stone		PVC foil laminated on MDF	SST	6-11 Days†	Gloss Stone	Modern/Traditional	MFC/PVC	NO	NO	YES	YES	
Classic Painted (all colours)		Painted finish on MDF	•	3-4 Weeks	Lissa Oak/Ivory	Modern/Traditional	MFC/Painted	YES	YES	YES	YES	
Concept Painted (all colours)		Painted finish on MDF with recessed handle	•	3-4 Weeks	Lissa Oak/Ivory	Modern/Traditional	MFC/Painted	NO	YES	NO	YES	
Fusion Painted (all colours)		Painted finish on MDF with integral handle	•	3-4 Weeks	Lissa Oak/Ivory	Modern	MFC/Painted	NO	YES	YES	YES	
Fusion Gloss White		High gloss lacquer finish on MDF with integral handle	JGW	6-11 Days†	Gloss White	Modern	MFC/Gloss	NO	NO	YES	YES	
Fusion Gloss Anthracite		High gloss lacquer finish on MDF with integral handle	JGA	6-11 Days†	Aluminium	Modern	MFC/Gloss	NO	NO	YES	YES	
Fusion Gloss Ivory		High gloss lacquer finish on MDF with integral handle	JGV	6-11 Days†	Gloss Ivory	Modern	MFC/Gloss	NO	NO	YES	YES	
Fusion Gloss Grey		High gloss lacquer finish on MDF with integral handle	JGY	6-11 Days†	Aluminium	Modern	MFC/Gloss	NO	NO	YES	YES	
Fusion Gloss Light Grey		High gloss lacquer finish on MDF with integral handle	JGL	6-11 Days†	Aluminium	Modern	MFC/Gloss	NO	NO	YES	YES	
Fusion Gloss Cashmere		High gloss lacquer finish on MDF with integral handle	JGC	6-11 Days†	Gloss Cashmere	Modern	MFC/Gloss	NO	NO	YES	YES	
Fusion Gloss Limestone		High gloss lacquer finish on MDF with integral handle	JGS	6-11 Days†	Aluminium	Modern	MFC/Gloss	NO	NO	YES	YES	
4		Shaker Lissa Oak Wood	Solid oak frame with oak veneered centre panel	WLS	6-11 Days†	Lissa Oak	Modern/Traditional	MFC/Veneer	YES	NO	YES	YES
		Shaker Sand Oak Wood	Solid oak frame with oak veneered centre panel	WSO	6-11 Days†	Sand Oak	Modern/Traditional	MFC/Veneer	YES	NO	YES	YES
	Fusion Shaker Gloss White	High gloss lacquer finish on MDF with integral handle	JSW	6-11 Days†	Gloss White	Modern	MFC/Gloss	NO	NO	YES	YES	
5	Heritage Painted (all colours)	Solid ash frame with a raised veneered centre panel, painted	•	3-4 Weeks	Lissa Oak/Ivory	Modern/Traditional	MFC/Painted	YES	YES	YES	YES	
	Shaker Wood (all colours)	Solid ash frame with veneered centre panel, painted	•	3-4 Weeks	Lissa Oak/Ivory	Modern/Traditional	MFC/Painted	YES	YES	YES	YES	
	Richmond Painted (all colours)	Solid ash frame with a veneered centre panel, painted	•	3-4 Weeks	Lissa Oak/Ivory	Modern/Traditional	MFC/Painted	YES	YES	YES	YES	
	Shaker Stately Painted (all colours)	Solid ash frame with veneered centre panel, painted	•	3-4 Weeks	Lissa Oak/Ivory	Modern/Traditional	MFC/Painted	YES	YES	YES	YES	

* These ranges supplied pre-assembled † Working Days †† 3-4 Weeks lead time
• For painted order codes please see page 7

• If the delivery date is put back after the units have been made or if delivery is refused, Omega PLC "reserve the right" to apply a reasonable charge for storage or re-delivery.



LET YOUR COLOURS SHOW

AN OPEN INVITATION TO EXPRESS YOUR PERSONAL STYLE

A selection of English Rose Kitchens are available in a range of 14 fashionable and contemporary colours.

Opaco, Shaker, Classic, Davenport, Fusion, Richmond, Shaker Wood, Stately Shaker, Heritage and Concept Painted can all be supplied in these elegant shades, designed to work well on their own or combined with other colours and textures.

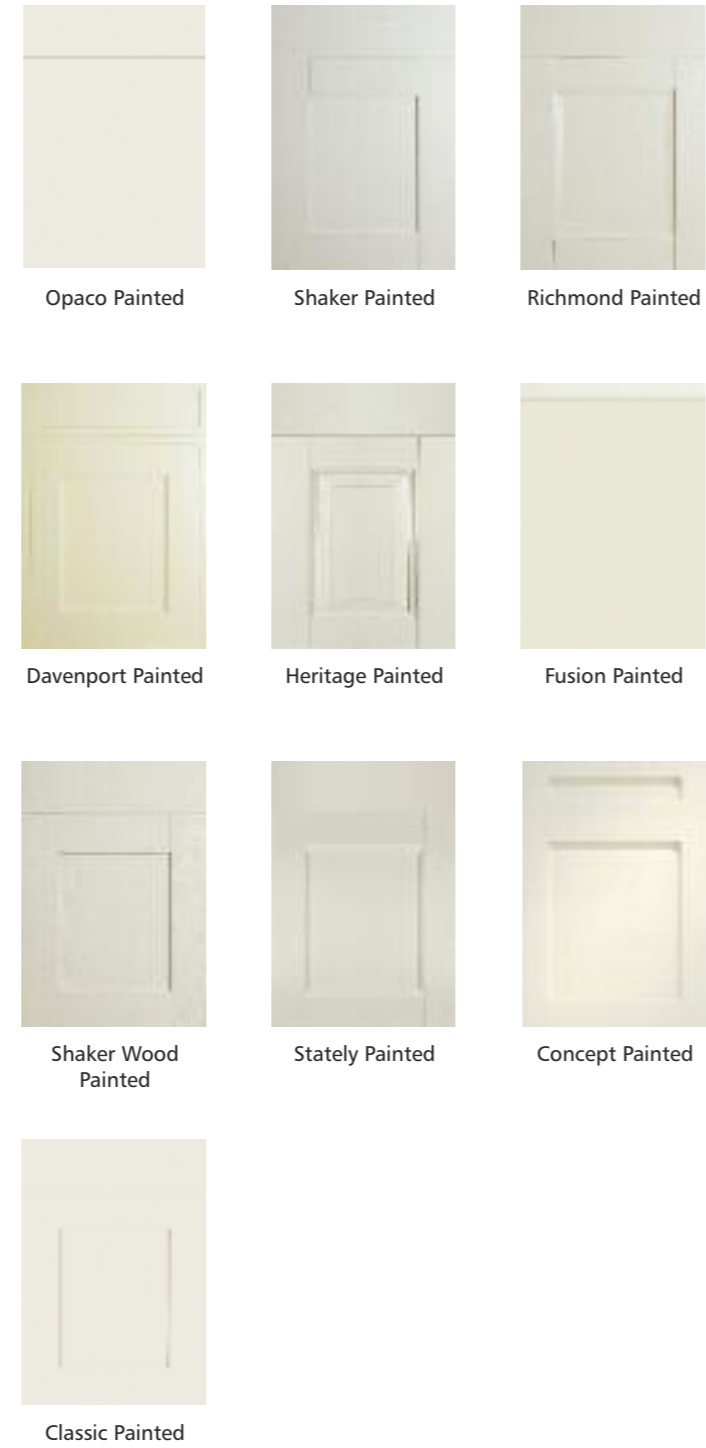

DELIVERY DETAILS - OUR PAINTED COLLECTION IS MADE TO ORDER, SO PLEASE ALLOW 3-4 WEEKS FOR DELIVERY.

The colours shown in this price list are as accurate as the printing process allows, therefore we recommend that you ask your retailer to show you a sample of the colour before placing your order.

PAINTED ORDER CODES

2 PRICE GROUP	FPR	Opaco Green	3 PRICE GROUP	PGR	Davenport Green	5 PRICE GROUP	CPH	Richmond Hickory
	FPH	Opaco Hickory		PHK	Davenport Hickory		CPS	Richmond Steel Blue
	FVV	Opaco Ivory		PVY	Davenport Ivory		CPR	Richmond Green
	FPB	Opaco Painted Light Blue		PLB	Davenport Light Blue		WIV	Richmond Ivory
	FPL	Opaco Light Grey		PLG	Davenport Light Grey		CPB	Richmond Light Blue
	FPO	Opaco Oyster		POY	Davenport Oyster		CPL	Richmond Light Grey
	FPD	Opaco Primed		PPD	Davenport Primed		CPO	Richmond Oyster
	FPY	Opaco Sage Grey		PSG	Davenport Sage Grey		CPY	Richmond Sage Grey
	FPS	Opaco Steel Blue		PSB	Davenport Steel Blue		CPE	Richmond Cashmere
	FPE	Opaco Cashmere		PTU	Davenport Cashmere		CPT	Richmond White
	FPT	Opaco White		PWH	Davenport Platinum White		CPX	Richmond Oxford Blue
	FPX	Opaco Oxford Blue		PPX	Davenport Oxford Blue		CPM	Richmond Limestone
	FPM	Opaco Limestone		PPM	Davenport Limestone		CPK	Richmond Anthracite
	FPK	Opaco Anthracite		PPK	Davenport Anthracite		CPJ	Richmond Sandstone
FPJ	Opaco Sandstone	PJ	Davenport Sandstone					
SFR	Shaker Painted Green	JPR	Fusion Green	NPR	Heritage Green			
SFH	Shaker Painted Hickory	JPH	Fusion Hickory	NPH	Heritage Hickory			
SVV	Shaker Painted Ivory	JPV	Fusion Ivory	NPV	Heritage Ivory			
SFB	Shaker Painted Light Blue	JPB	Fusion Light Blue	NPB	Heritage Light Blue			
SFL	Shaker Painted Light Grey	JPL	Fusion Light Grey	NPL	Heritage Light Grey			
SFO	Shaker Painted Oyster	JPO	Fusion Oyster	NPO	Heritage Oyster			
SFY	Shaker Painted Sage Grey	JPD	Fusion Primed	NPD	Heritage Primed			
SFS	Shaker Painted Steel Blue	JPY	Fusion Sage Grey	NPY	Heritage Sage Grey			
SFE	Shaker Painted Cashmere	JPS	Fusion Steel Blue	NPE	Heritage Cashmere			
SFT	Shaker Painted White	JPE	Fusion Cashmere	NPT	Heritage White			
SFX	Shaker Painted Oxford Blue	JPT	Fusion White	NPS	Heritage Steel Blue			
SFM	Shaker Painted Limestone	JPX	Fusion Oxford Blue	NPX	Heritage Oxford Blue			
SFK	Shaker Painted Anthracite	JPM	Fusion Limestone	NPM	Heritage Limestone			
SFJ	Shaker Painted Sandstone	JPK	Fusion Anthracite	NPK	Heritage Anthracite			
		JPJ	Fusion Sandstone	NPJ	Heritage Sandstone			
		EPR	Classic Green	WTR	Shaker Wood Painted Green			
		EPH	Classic Hickory	WTH	Shaker Wood Painted Hickory			
		EPV	Classic Ivory	WTV	Shaker Wood Painted Ivory			
		EPB	Classic Painted Light Blue	WTB	Shaker Wood Painted Light Blue			
		EPL	Classic Light Grey	WTL	Shaker Wood Painted Light Grey			
		EPO	Classic Oyster	WTO	Shaker Wood Painted Oyster			
		EPD	Classic Primed	WTY	Shaker Wood Painted Sage Grey			
		EPY	Classic Sage Grey	WTS	Shaker Wood Painted Steel Blue			
		EPS	Classic Steel Blue	WTE	Shaker Wood Painted Cashmere			
		EPE	Classic Cashmere	WTT	Shaker Wood Painted White			
		EPT	Classic White	WTD	Shaker Wood Painted Primed			
		EPX	Classic Oxford Blue	WTX	Shaker Wood Painted Oxford Blue			
		EPM	Classic Limestone	WTM	Shaker Wood Painted Limestone			
		EPK	Classic Anthracite	WTK	Shaker Wood Painted Anthracite			
		EPJ	Classic Sandstone	WTJ	Shaker Wood Painted Sandstone			
		UPR	Concept Green	APD	Stately Shaker Painted Primed			
		UPH	Concept Hickory	APB	Stately Shaker Painted Light Blue			
		UPV	Concept Ivory	APR	Stately Shaker Painted Green			
		UPB	Concept Painted Light Blue	APY	Stately Shaker Painted Sage Grey			
		UPL	Concept Light Grey	APO	Stately Shaker Painted Oyster			
		UPO	Concept Oyster	APV	Stately Shaker Painted Ivory			
		UPD	Concept Primed	APT	Stately Shaker Painted White			
		UPY	Concept Sage Grey	APE	Stately Shaker Painted Cashmere			
		UPS	Concept Steel Blue	APL	Stately Shaker Painted Light Grey			
		UPE	Concept Cashmere	APH	Stately Shaker Painted Hickory			
		UPT	Concept White	APS	Stately Shaker Painted Steel Blue			
		UPX	Concept Oxford Blue	APX	Stately Shaker Painted Oxford Blue			
		UPM	Concept Limestone	APM	Stately Shaker Painted Limestone			
		UPK	Concept Anthracite	APK	Stately Shaker Painted Anthracite			
		UPJ	Concept Sandstone	APJ	Stately Shaker Painted Sandstone			

(Price shown in brackets denotes full unit price with oak drawers)

HIGHLINE BASE UNITS

Single Base Unit	Double Base Unit	Belfast Sink Base Unit	Breakfront Unit with Shelf	Breakfront Unit with Pull Out Wirework (R/H illus)	Base Unit with 2 Pull Out Arena Shelves	Base Unit with Pull Out Chrome Wine Rack	Base Unit with 2 Pull Out Wirework	Base Unit with 2 Pull Out Wirework and Stainless Steel Fascia	Base c/w 2 (140mm deep) Veg Baskets	Type 2 Pullout	Type 3 Pullout c/w 2 Internal Drawers
300mm BU30 £130	800mm BU80 £253	600mm BEL60 £131	300mm BFRS30 £158	300mm c/w Arena Shelves L/H BFR30LA £378	300mm B30AW £330	400mm B40WRL £458	150mm BU15 £220	150mm BU15SS £344	400mm B40V £237	300mm B30PT2 £254	300mm B30PT3 £309 (£385)
400mm BU40 £144	900mm BU90 £259			300mm c/w Arena Shelves R/H BFR30RA £378	300mm c/w Graphite Wirework B30BW £364	400mm B40WRR £458	c/w Graphite Wirework 150mm BU15B £243	c/w Graphite Wirework 150mm BU15BSS £380	500mm B50V £254	400mm B40PT2 £272	400mm B40PT3 £330 (£417)
450mm BU45 £147	1000mm BU100 £259								600mm B60V £275	450mm B45PT2 £278	450mm B45PT3 £339 (£430)
500mm BU50 £147										500mm B50PT2 £282	500mm B50PT3 £344 (£439)
600mm BU60 £165										600mm B60PT3 £369 (£474)	600mm B60PT2 £306

HIGHLINE CORNER BASE UNITS

Base Unit with Le-Mans Pull Out Storage* (L/H illus)	Corner Base Unit* (L/H illus)	L Shaped Corner Base Unit	Corner Carousel Base Unit* (L/H illus)	Corner Base Unit c/w Vario Pull Out Storage* (R/H illus)	L Shaped Corner Carousel Base Unit
900mm L/H c/w 450mm door BCC145ML £777	800mm c/w 400mm door BC80 £233	930/930mm BC93 £372	1000mm c/w 600mm door BCM100A £554	900mm L/H c/w Arena Shelves 450mm door BCM145LA £897	930/930mm c/w Arena Shelves BCM93A £657
1000mm L/H c/w 500mm door BCC100ML £806	1000mm L/H c/w 500mm door BC90 £239		1000mm c/w 600mm door BCM100A £558	1000mm L/H c/w Arena Shelves 500mm door BCM100LA £903	930/930mm c/w Graphite Wirework BCM93B £726
1000mm L/H c/w 600mm door BCC160ML £841	1000mm c/w 450mm door BC100 £239			1000mm L/H c/w Arena Shelves 600mm door BCM160LA £906	
900mm R/H c/w 450mm door BCC145MR £777	1000mm c/w 500mm door BC120 £251			900mm R/H c/w Arena Shelves 450mm door BCM145RA £897	
1000mm R/H c/w 500mm door BCC100MR £806				1000mm R/H c/w Arena Shelves 500mm door BCM100RA £903	
1000mm R/H c/w 600mm door BCC160MR £841				1000mm R/H c/w Arena Shelves 600mm door BCM160RA £906	

* Corner base units do not include a blanking panel. The end support panel ESP can be used for this purpose if required.

DRAWERLINE BASE UNITS

Single Base Unit	Double Base Unit	Base Unit 1 Dummy Drawer	Base Unit Dummy Drawer	Base Unit 2 Dummy Drawers	Breakfront Unit with Shelf	Breakfront Unit with Pull Out Wirework (R/H illus)	Base Unit with Pull Out Arena Shelves/Dummy Drawer	Base Unit with Dummy Drawer & Pull Out Wine Rack	Base c/w 2 (140mm deep) Veg Baskets	Type 1 Pullout c/w 1 Pan Drawer, 1 Internal Drawer
300mm BD30 £198 (£242)	800mm BD80 £385 (£484)	800mm BSD80 £323 (£372)	300mm BDD30 £137	800mm BDD80 £260	300mm BFRS30D £161	300mm c/w Arena Shelves R/H BFR30DLA £388	300mm BDD30AW £338	400mm BDD40WRR £463	400mm BD40V £303 (£349)	300mm BD30PT1 £333
400mm BD40 £210 (£259)	900mm BD90 £394 (£496)	900mm BSD90 £380	400mm BDD40 £147	900mm BDD90 £265		300mm c/w Arena Shelves L/H BFR30DRA £388	300mm c/w Graphite Wirework BDD30BW £372	500mm BD50V £323 (£373)	500mm BD50V £323 (£373)	400mm BD40PT1 £351
450mm BD45 £215 (£266)	1000mm BD100 £397 (£502)	1000mm BSD100 £384	450mm BDD45 £151	1000mm BDD100 £265				600mm BD60V £343 (£397)	600mm BD60V £343 (£397)	450mm BD45PT1 £360
500mm BD50 £217 (£269)			500mm BDD50 £151							500mm BD50PT1 £366
600mm BD60 £233 (£290)			600mm BDD60 £165							600mm BD60PT1 £390

DRAWERLINE CORNER BASE UNITS

Corner Base Unit*	Corner Carousel Base Unit*	Corner Base Unit c/w Vario Pull Out Storage* (R/H illus)	Base Unit with Le-Mans Pull Out Storage* (L/H illus)
800mm c/w 400mm door BCD80 £299 (£349)	1000mm c/w 500mm door & Arena Shelves BCCD10A £554 (£604)	900mm L/H c/w 450mm door & Arena Shelves BCMD14LA £963 (£1,011)	900mm L/H c/w 450mm door BCCD14ML £845 (£893)
900mm c/w 450mm door BCD90 £306 (£357)	1000mm c/w 600mm door & Arena Shelves BCCD12A £558 (£612)	1000mm L/H c/w 500mm door & Arena Shelves BCMD10LA £970 (£1,019)	900mm R/H c/w 450mm door BCCD14MR £845 (£893)
1000mm c/w 500mm door BCD100 £308 (£360)		1000mm L/H c/w 600mm door & Arena Shelves BCMD16LA £974 (£1,028)	1000mm L/H c/w 500mm door BCCD10MR £876 (£925)
1000mm c/w 600mm door BCD120 £319 (£376)		1000mm R/H c/w 500mm door & Arena Shelves BCMD10RA £970 (£1,019)	1000mm R/H c/w 500mm door BCCD10ML £968 (£1,017)
		1000mm R/H c/w 600mm door & Arena Shelves BCMD16RA £974 (£1,028)	1000mm R/H c/w 600mm door BCCD16MR £910 (£964)
			1000mm L/H c/w 600mm door BCCD16ML £910 (£964)

* Corner base units do not include a blanking panel. The end support panel ESP can be used for this purpose if required.

ENGLISH ROSE CONTACT – HANDLE-LESS KITCHENS: Certain units will require a handle and are indicated by the following symbols:

- ◆ Select from face fixed handle suite 609
- ◇ Select from handle suite 653 (for use with 'English Rose Contact' aluminium extrusions) or face fixed handle suite 609
- ★ Drawer surcharge applies. Please add £45 per drawer
- ▲ Any unit with this symbol requires a 'CN' adding to the code. Please see page 80 for details

DRAWER PACK UNITS

5 Drawer Pack	4 Pan Drawer Pack	3 Pan Drawer Pack	2 Drawer Unit	2 Drawer Unit c/w Internal Drawer	Base with 1 Drawer and 2 Wicker Baskets	Sink Pan Drawer Unit 1 Dummy top drawer, 1 cut out drawer option
300mm DP30 £467 (£688)	500mm PD50/4 £435 (£662)	500mm PD50/3 £362 (£553)	600mm PD60/2 £304 (£454)	600mm PD60/3 £381 (£588)	500mm WB50 £292 (£342)	900mm PDS90/3 £446
400mm DP40 £488 (£734)	600mm PD60/4 £456 (£703)	600mm PD60/3 £381 (£588)	800mm PD80/2 £346 (£526)	800mm PD80/3 £449 (£692)	Oak option 500mm WB50OAK £441 (£490)	2 cut out drawer option 900mm PDS90/3P2 £457
450mm DP45 £500 (£755)	800mm PD80/4 £544 (£825)	800mm PD80/3 £449 (£692)	900mm PD90/2 £397 (£559)	900mm PD90/3 £513 (£742)		
500mm DP50 £509 (£771)	900mm PD90/4 £597 (£881)	900mm PD90/3 £513 (£742)	1000mm PD100/2 £414 (£577)	1000mm PD100/3 £539 (£773)		
600mm DP60 £531 (£818)	1000mm PD100/4 £638 (£930)					
800mm DP80 £640 (£959)						
900mm DP90 £681 (£1,019)						
1000mm DP100 £736 (£1,086)						

STANDARD WALL UNITS

Single Wall Unit	Double Wall Unit	Wall Bridging Unit	Double Wall Bridging Unit	Microwave Unit	Up & Over Flap Unit	Bi-Fold Wall Bridging Unit
Standard	Standard	600/288mm WBG60 £128	600/576mm WDBG60 £230	600/720mm WU60/MW £242	500/720mm WU50/VR £259	600/720mm WBF60 £341
300/720mm WU30 £113	600/720mm (c/w 2 doors) WU60/2 £179	900/288mm WBG90 £168	900/576mm WDBG90 £267		600/720mm WU60/VR £275	800/720mm WBF80 £393
400/720mm WU40 £127	800/720mm WU80 £255					900/720mm WBF90 £413
450/720mm WU45 £132	900/720mm WU90 £262					
500/720mm WU50 £135	1000/720mm WU100 £269					
600/720mm WU60 £151						

Note: 190mm height clearance required. No pelmet can be used if using handle suite 653.
Do not use in corner with WC60.

CORNER WALL UNITS

L Shaped Corner Wall Unit	Standard Corner Wall Unit
Standard	WC60 £217
630/630/720mm WCL630 £327	



(Price shown in brackets denotes full unit price with oak drawers)

STANDARD HEIGHT GLAZED WALL UNITS (720mm)

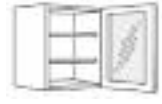

Standard Height Glazed Wall Unit

Aluminium Frame with Reflective Glass

c/w Reflective Glass & MFC Shelves	400mm	WG40RFL	£216	500mm	WG50RFL	£238
c/w Reflective Glass & Sirius LED Downlights	400mm	WG40RFLSIR*	£273	500mm	WG50RFLSIR*	£297
c/w Reflective Glass & Halo LED Downlights	400mm	WG40RFLLED*	£300	500mm	WG50RFLLED*	£324
c/w Reflective Glass & Edge Lit Shelves	-			500mm	WG50RFLSH*	£331

* These glazed wall units are supplied with glass shelves

ACCESSORY BASE/WALL UNITS

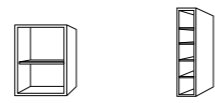

Open Unit

Wine Rack

500/720/300mm WOP50	£114	150/720/300mm WR15	£72
Carcase colour only		Carcase colour only	

EURO HEIGHT UNITS



Type 1 Single Oven Housing Highline	Type 2 Single Oven Housing Drawerline	Type 3 Single Oven Housing	Type 6 Double Oven Housing	Type 8 Microwave/Steam Oven/coffee Machine Housing	Type 9 Microwave/Steam Oven/coffee Machine Housing	Type 10 Microwave/Steam Oven/coffee Machine Housing	Type 11 Microwave/Steam Oven/coffee Machine Housing	Type 1 Fridge/ Freezer Housing	Type 1 Pantry Unit
600/1492mm EOH60 T1 £210	600/1492mm EOH60 T2 £278 (£336)	c/w 3 Drawers 600/1492mm EOH60 T3 £426 (£633)	c/w 2 Drawers 600/1492mm EOH60 T6 £322 (£455)	EOH60 T8 £299 (£357)	EOH60 T9 £515 (£780)	EOH60 T10 £317 (£374) <i>Supplied with Stainless Steel filler</i>	EOH60 T11 £533 (£797) <i>Supplied with Stainless Steel filler</i>	c/w 2 Drawers 600/1492mm EPF60 T1 £400 (£532)	c/w 2 Drawers 600/1492mm EP60 T1 £409 (£542)

APPLIANCE UNITS

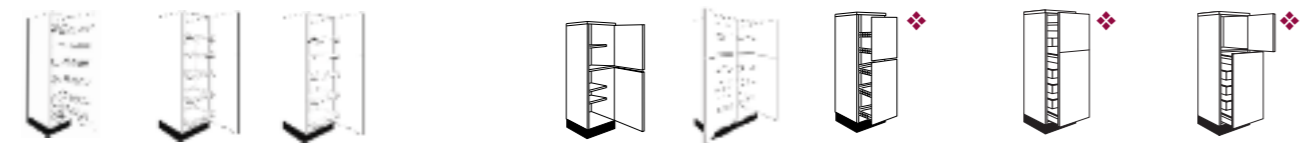

Tandem Larder Unit	Tandem Solo Unit	Convoy Premio Unit <i>(illus r/h)</i>	Larder Unit	Double Larder Unit	Larder Unit c/w Pull Out Wirework	Type 1 Pullout Larder Unit	Type 2 Pullout Larder Unit
500/2117mm LU50TDM £1,204	600/2117mm LU60SOLO £946	600/2117mm (L/H) LU60CONVL £1,310 600/2117mm (R/H) LU60CONVR £1,310 <i>(Please specify handing of door)</i>	300/2117mm LU30 £338 400/2117mm LU40 £356 500/2117mm LU50 £374 600/2117mm LU60* £386	1000/2117mm LU100 £939	With Arena Shelves LU30A £896 LU40A £997 LU50A £1,097	c/w 3 Pan Drawers, 4 Internal Drawers 300/2117mm LU30P T1 £823 400/2117mm LU40P T1 £866 500/2117mm LU50P T1 £910	c/w 2 Pan Drawers, 3 Internal Drawers 300/2117mm LU30P T2 £686 400/2117mm LU40P T2 £723 500/2117mm LU50P T2 £759

ENGLISH ROSE CONTACT – HANDLE-LESS KITCHENS: Certain units will require a handle and are indicated by the following symbols:

- ◆ Select from face fixed handle suite 609
- ◇ Select from handle suite 653 (for use with 'English Rose Contact' aluminium extrusions) or face fixed handle suite 609
- ★ Drawer surcharge applies. Please add £45 per drawer
- ▲ Any unit with this symbol requires a 'CN' adding to the code. Please see page 80 for details

APPLIANCE AND TALL UNITS

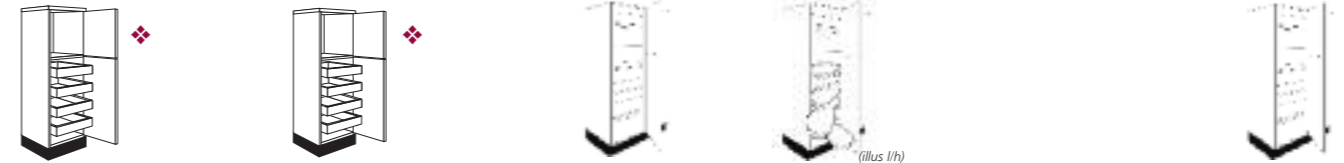

Type 3 Larder Unit	Type 4 Larder Unit	Type 1 1000 Corner Larder to Larder	Type 2 1000 Corner Larder to Larder with Le-Mans Pull Out Storage	Type 3 1000 Corner Larder to Base
c/w 6 Internal Drawers 300/2117mm LU30P T3 £865 (£1,095) 400/2117mm LU40P T3 £910 (£1,172) 500/2117mm LU50P T3 £953 (£1,239) 600/2117mm LU60P T3 £1,034 (£1,350)	c/w 4 Internal Drawers 300/2117mm LU30P T4 £686 (£840) 400/2117mm LU40P T4 £721 (£896) 500/2117mm LU50P T4 £757 (£948) 600/2117mm LU60P T4 £807 (£1,017)	400/2117mm LUC104T1 £446 500/2117mm LUC105T1 £484 600/2117mm LUC106T1 £482	500/2117mm (L/H) LUC105T2L £1,757 500/2117mm (R/H) LUC105T2R £1,757 600/2117mm (L/H) LUC106T2L £1,817 600/2117mm (R/H) LUC106T2R £1,817	with Graphite Wirework 500/2117mm (L/H) LUCB105T2L £1,942 500/2117mm (R/H) LUCB105T2R £1,942 600/2117mm (L/H) LUCB106T2L £2,008 600/2117mm (R/H) LUCB106T2R £2,008
400/2117mm LUC104 T3 £490	500/2117mm LUC105 T3 £527	600/2117mm LUC106 T3 £526		

* Larder to larder units do not include a blanking panel

(Please specify handing of Le Mans) *(Please specify handing)*

APPLIANCE AND TALL UNITS



Type 4 1000 Corner Larder to Base with Le-Mans Pull Out Storage	1000 Butlers Larder with Wine Racks
---	-------------------------------------

500/2117mm (L/H) LUC105 T4L £1,796 500/2117mm (R/H) LUC105 T4R £1,796 600/2117mm (L/H) LUC106 T4L £1,857 600/2117mm (R/H) LUC106 T4R £1,857 <i>(Please specify handing of Le Mans)</i>	with Graphite Wirework 500/2117mm (L/H) LUCB105 T4L £1,985 500/2117mm (R/H) LUCB105 T4R £1,985 600/2117mm (L/H) LUCB106 T4L £2,052 600/2117mm (R/H) LUCB106 T4R £2,052 <i>(Please specify handing)</i>	1000/2117mm LUC100BUT £996 <i>Please note: This unit is only available on Lissa Oak cabinet</i>
--	---	--

BUTLERS LARDER ACCESSORY ITEMS

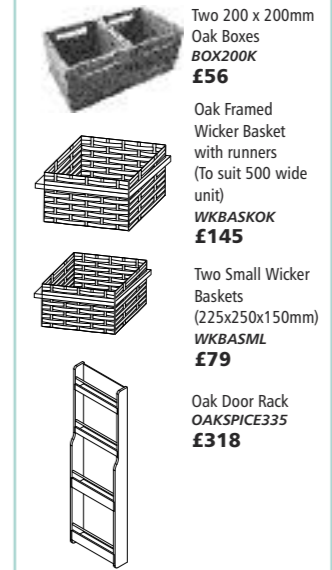

Two 200 x 200mm Oak Boxes
BOX200K
£56

Oak Framed Wicker Basket with runners (To suit 500 wide unit)
WKBASKOK
£145

Two Small Wicker Baskets (225x250x150mm)
WKBASML
£79

Oak Door Rack
OAKSPICE335
£318



ENGLISH ROSE CONTACT – HANDLE-LESS KITCHENS: Certain units will require a handle and are indicated by the following symbols:

- ◆ Select from face fixed handle suite 609
- ◆ Select from handle suite 653 (for use with 'English Rose Contact' aluminium extrusions) or face fixed handle suites 609
- ★ Drawer surcharge applies. Please add £45 per drawer
- ▲ Any unit with this symbol requires a 'CN' adding to the code. Please see page 80 for details

APPLIANCE UNITS	Built Under Oven Housing	Built Under Oven Housing with drawer	Type 1 Double Oven Housing	Type 2 Double Oven Housing	Type 3 Double Oven Housing	Type 5 Single Oven/Microwave Unit	Type 6 Single Oven Housing	Type 7 Single Oven Housing	Type 8 Single Oven Housing	Type 9 Microwave/Steam Oven/coffee Machine Housing	Type 10 Microwave/Steam Oven/coffee Machine Housing	Type 11 Microwave/Steam Oven/coffee Machine Housing
	600mm BUOH £97	600mm BUOHD £172	600/2117mm OH60 T1 £318	c/w 2 Drawers 600/2117mm OH60 T2 £466 (£616)	c/w 3 Drawers 600/2117mm OH60 T3 £541 (£731)	600/2117mm OH60 T5 £313	600/2117mm OH60 T6 £429 (£486)	600/2117mm OH60 T7 £497 (£612)	600/2117mm OH60 T8 £645 (£909)	OH60 T9 £518 (£633)	OH60 T10 £464 (£613)	OH60 T11† £481 (£631)

APPLIANCE UNITS	Type 12 Microwave/Steam Oven/coffee Machine Housing	Type 13 Microwave/Steam Oven/coffee Machine Housing	Type 1 Fridge/Freezer Housing	Type 2 Fridge/Freezer Housing	Type 5 Fridge & Freezer Housing	Type 6 Combi Fridge/Freezer Housing
	OH60 T12 £316	OH60 T13† £333	600/2117mm FFH60 T1 £396	c/w 2 Drawers 600/2117mm FFH60 T2 £544 (£694)	600/2117mm FFH60 T5 £365	600/2117mm FFH60 T6 £373

† Supplied with Stainless Steel filler

Please refer to fascia matrix on page 57.

INTEGRATED APPLIANCE FASCIAS	Semi Integrated Dishwasher Fascia	Highline Integrated Fridge/Freezer Fascia	Drawerline Integrated Fridge/Freezer Fascia	Integrated Hood Fascia	Highline Dishwasher Fascia	Drawerline Dishwasher Fascia
	600mm IFS60 £44	600mm IF60FR £72	600mm IFD60FR £72	600/450mm IF60EXT £48	450mm Slimline IF45 £59	450mm Slimline IFD45 £62
					600mm Fully Integrated IF60DW £72	600mm Fully Integrated IFD60DW £72



Accessories

Panels	End Support Panel/Add on Base End Panel 940 x 670	Graphite End Support Panel/Add on Base End Panel 940 x 670 MFC	Aluminium End Support Panel/Add on Base End Panel 920 x 670 MFC	Standard Wall Add On End Panel 760 x 375	Euro Height Add On Base End Panel 1562 x 670	Multi Purpose Panel/Larder Add On End Panel 2400 x 670	Aluminium Multi Purpose Panel/Larder Add On End Panel 2347 x 670 MFC	Graphite Multi Purpose Panel/Larder Add On End Panel 2400 x 670 MFC	Dresser Add On End Panel/Two Wall Ends 1584 x 375	Breakfast Bar Back Panel 940 x 2010	Aluminium Breakfast Bar Back Panel 940 x 2010 MFC	Graphite Breakfast Bar Back Panel 940 x 2010 MFC
Contemporary Driftwood	ESPMDW £34	ESP1GR £34	ESP1AL £34	EPWMDW £21	EPMDW £70	MPPMDW £88	MPP1AL £111	MPP1GR £111	EPWMDW £40	BBBMDW £88	BBB1AL £87	BBB1GR £87
Contemporary Lissa Oak	ESPLMH £34	ESP1GR £34	ESP1AL £34	EPWMLH £21	EPMLH £70	MPPMLH £88	MPP1AL £111	MPP1GR £111	EPWMLH £40	BBBMLH £88	BBB1AL £87	BBB1GR £87
Contemporary White Avola	ESPMW £34	ESP1GR £34	ESP1AL £34	EPWMMW £21	EPMAW £70	MPPMAW £88	MPP1AL £111	MPP1GR £111	EPWMAW £40	BBBMAW £88	BBB1AL £87	BBB1GR £87
Contemporary Brown Grey Avola	ESPMAG £34	ESP1GR £34	ESP1AL £34	EPWMMAG £21	EPMAG £70	MPPMAG £88	MPP1AL £111	MPP1GR £111	EPWMMAG £40	BBBPMAG £88	BBB1AL £87	BBB1GR £87
Contemporary Sand Oak	ESPMO £34	ESP1GR £34	ESP1AL £34	EPWMSO £21	EPMSO £70	MPPMSO £88	MPP1AL £111	MPP1GR £111	EPWMSO £40	BBBMSO £88	BBB1AL £87	BBB1GR £87

Panels	Island End Panel 716 x 860 Supplied Horizontal Grain	100mm Wide Cornice/Pelmet/Filler 2400 x 100	100mm Graphite Wide Cornice/Pelmet/Filler 2400 x 100 MFC	100mm Aluminium Filler Panel - 18mm MFC - 2297mm Edged, 1 long & 2 Short	Plinth with Seal 150 x 2750 Horizontal Grain	Graphite Plinth with Seal 150 x 2750	Mirrored Plinth - No Seal 2650mm	5 Metre Roll of Edging Tape 22mm x 2mm	10 Metre Roll of Graphite Edging Tape	10 Metre Aluminium Edging Tape - Unglued PVC	5 Metre Roll Graphite Edging Tape (1.3mm thick)	5 Metre Aluminium Edging Tape (1.3mm thick)
Contemporary Driftwood	IEPHORMDW £34	TFMDW £29	TF1GR £30	TF1AL £30	PLMDW £35	PLGR £34	PLMIR £84	ETSMDW £26	ETGR £17	ETAL £17	ETSGR £26	ETSAL £26
Contemporary Lissa Oak	IEPHORMLH £34	TFMLH £29	TF1GR £30	TF1AL £30	PLMLH £35	PLGR £34	PLMIR £84	ETSMLH £26	ETGR £17	ETAL £17	ETSGR £26	ETSAL £26
Contemporary White Avola	IEPHORMAW £34	TFMAW £29	TF1GR £30	TF1AL £30	PLMAW £35	PLGR £34	PLMIR £84	ETSMW £26	ETGR £17	ETAL £17	ETSGR £26	ETSAL £26
Contemporary Brown Grey Avola	IEPHORMAG £34	TFMAG £29	TF1GR £30	TF1AL £30	PLMAG £35	PLGR £34	PLMIR £84	ETSMAG £26	ETGR £17	ETAL £17	ETSGR £26	ETSAL £26
Contemporary Sand Oak	IEPHORMSO £34	TFMSO £29	TF1GR £30	TF1AL £30	PLMSO £35	PLGR £34	PLMIR £84	ETSMSO £26	ETGR £17	ETAL £17	ETSGR £26	ETSAL £26

PLEASE NOTE

All panels are edged on all 4 sides
Cornice/Pelmets/Pilasters are edged on 1 long and 2 short sides
Mirrored Plinths are edged on 2 long sides

(Price shown in brackets denotes full unit price with oak drawers)

HIGHLINE BASE UNITS

Single Base Unit	Double Base Unit	Belfast Sink Base Unit	Breakfront Unit with Shelf	Breakfront Unit with Pull Out Wirework (R/H illus)	Base Unit with 2 Pull Out Arena Shelves	Base Unit with Pull Out Chrome Wine Rack	Base with 2 Pull Out Wirework	Base Unit with 2 Pull Out Wirework and Stainless Steel Fascia	Base c/w 2 (140mm deep) Veg Baskets	Type 2 Pullout	Type 3 Pullout c/w 2 Internal Drawers
300mm BU30 £150	800mm BU80 £293	600mm BEL60 £151	300mm BFR530 £182	300mm c/w Arena Shelves L/H BFR30LA £436	300mm B30AW £381	400mm B40WRL £529	150mm BU15 £344	150mm BU15SS £344	400mm B40V £273	300mm B30PT2 £272	300mm B30PT3 £330 (£433)
400mm BU40 £166	900mm BU90 £299			300mm c/w Arena Shelves R/H BFR30RA £436	300mm c/w Graphite Wirework B30BW £421	400mm B40WRR £529	c/w Graphite Wirework 150mm BU15B £380	c/w Graphite Wirework 150mm BU15BSS £380	500mm B50V £293	400mm B40PT2 £315	400mm B40PT3 £354 (£468)
450mm BU45 £170	1000mm BU100 £299								600mm B60V £318	450mm B45PT2 £300	450mm B45PT3 £363 (£482)
500mm BU50 £170										500mm B50PT2 £304	500mm B50PT3 £368 (£492)
600mm BU60 £190										600mm B60PT3 £397 (£532)	600mm B60PT2 £354

HIGHLINE CORNER BASE UNITS

Base Unit with Le-Mans Pull Out Storage* (L/H illus)	Corner Base Unit* (L/H illus)	L Shaped Corner Base Unit	Corner Carousel Base Unit* (L/H illus)	Corner Base Unit c/w Vario Pull Out Storage* (R/H illus)	L Shaped Corner Carousel Base Unit
900mm L/H c/w 450mm door BCC145ML £898	800mm c/w 400mm door BC80 £269	930/930mm BC93 £430	1000mm c/w 600mm door BCM100A £640	900mm L/H c/w Arena Shelves 450mm door BCM145LA £913	930/930mm c/w Arena Shelves BCC93A £759
1000mm L/H c/w 500mm door BCC100ML £931	1000mm L/H c/w 500mm door BCCB100ML £1,029		1000mm c/w 600mm door & Arena Shelves BCC120A £645	1000mm L/H c/w Arena Shelves 500mm door BCM100LA £920	930/930mm c/w Graphite Wirework BCC93B £838
1000mm L/H c/w 600mm door BCC160ML £972	1000mm L/H c/w 600mm door BCC160MR £1,074			1000mm L/H c/w Arena Shelves 600mm door BCM160LA £926	
900mm R/H c/w 450mm door BCC145MR £898	900mm R/H c/w 450mm door BCCB145MR £992			900mm R/H c/w Arena Shelves 450mm door BCM145RA £913	
1000mm R/H c/w 500mm door BCC100MR £931	1000mm R/H c/w 500mm door BCCB100MR £1,029			1000mm R/H c/w Arena Shelves 500mm door BCM100RA £920	
1000mm R/H c/w 600mm door BCC160MR £972	1000mm R/H c/w 600mm door BCCB160MR £1,074			1000mm R/H c/w Arena Shelves 600mm door BCM160RA £926	

* Corner base units do not include a blanking panel. The end support panel ESP can be used for this purpose if required.

DRAWERLINE BASE UNITS

Single Base Unit	Double Base Unit	Base Unit 1 Dummy Drawer	Base Unit Dummy Drawer	Base Unit 2 Dummy Drawers	Breakfront Unit with Shelf	Breakfront Unit with Pull Out Wirework (R/H illus)	Base Unit with Pull Out Arena Shelves/Dummy Drawer	Base Unit with Dummy Drawer & Pull Out Wine Rack	Base c/w 2 (140mm deep) Veg Baskets	Type 1 Pullout c/w 1 Pan Drawer, 1 Internal Drawer
300mm BD30 £228 (£273)	800mm BD80 £445 (£544)	800mm BSD80 £373 (£422)	300mm BDD30 £158	800mm BDD80 £300	300mm BFR530D £186	300mm c/w Arena Shelves R/H BFR30DLA £448	300mm BDD30AW £358	400mm BDD40WRR £489	400mm BD40V £326 (£396)	300mm BD30PT1 £384
400mm BD40 £242 (£292)	900mm BD90 £455 (£557)	900mm BSD90 £430	400mm BDD40 £170	900mm BDD90 £306		300mm c/w Arena Shelves L/H BFR30DRA £448	300mm c/w Graphite Wirework BDD30BW £395	500mm BD50V £347 (£423)	500mm BD50V £347 (£423)	400mm BD40PT1 £406
450mm BD45 £248 (£299)	1000mm BD100 £459 (£564)	1000mm BSD100 £435	450mm BDD45 £174	1000mm BDD100 £306				600mm BD60V £397 (£450)	600mm BD60V £397 (£450)	450mm BD45PT1 £416
500mm BD50 £250 (£303)			500mm BDD50 £174							500mm BD50PT1 £423
600mm BD60 £269 (£327)			600mm BDD60 £191							600mm BD60PT1 £450

DRAWERLINE CORNER BASE UNITS

Corner Base Unit*	Corner Carousel Base Unit*	Corner Base Unit c/w Vario Pull Out Storage* (R/H illus)	Base Unit with Le-Mans Pull Out Storage* (L/H illus)
800mm c/w 400mm door & Arena Shelves BCCD10A £640 (£690)	1000mm c/w 500mm door & Arena Shelves BCCD10A £640 (£690)	900mm L/H c/w 450mm door & Arena Shelves BCM14LA £980 (£1,160)	900mm L/H c/w 450mm door BCCD14ML £976 (£1,024)
900mm c/w 450mm door BCD90 £354 (£405)	1000mm c/w 600mm door & Arena Shelves BCCD12A £645 (£699)	1000mm L/H c/w 500mm door & Arena Shelves BCM10LA £987 (£1,169)	900mm R/H c/w 450mm door BCCD14MR £976 (£1,024)
1000mm c/w 500mm door BCD100 £356 (£408)		1000mm R/H c/w 500mm door & Arena Shelves BCM10RA £987 (£1,169)	1000mm L/H c/w 500mm door BCCD10MR £1,011 (£1,061)
1000mm c/w 600mm door BCD120 £369 (£426)		1000mm R/H c/w 600mm door & Arena Shelves BCM10RA £987 (£1,169)	1000mm R/H c/w 500mm door BCCD10MR £1,011 (£1,061)
		1000mm L/H c/w 600mm door & Arena Shelves BCM16LA £994 (£1,179)	1000mm L/H c/w 500mm door BCCD10MR £1,011 (£1,061)
		1000mm R/H c/w 600mm door & Arena Shelves BCM16RA £994 (£1,179)	1000mm L/H c/w 600mm door BCCD16ML £948 (£1,104)
			1000mm R/H c/w 600mm door BCCD16MR £948 (£1,104)
			1000mm L/H c/w 600mm door BCCD16ML £948 (£1,104)
			1000mm R/H c/w 600mm door BCCD16MR £948 (£1,104)

* Corner base units do not include a blanking panel. The end support panel ESP can be used for this purpose if required.

ENGLISH ROSE CONTACT – HANDLE-LESS KITCHENS: Certain units will require a handle and are indicated by the following symbols:

- ◆ Select from face fixed handle suite 609
- ◇ Select from handle suite 653 (for use with 'English Rose Contact' aluminium extrusions) or face fixed handle suite 609
- ★ Drawer surcharge applies. Please add £45 per drawer
- ▲ Any unit with this symbol requires a 'CN' adding to the code. Please see page 80 for details

DRAWER PACK UNITS

5 Drawer Pack	4 Pan Drawer Pack	3 Pan Drawer Pack	2 Drawer Unit	2 Drawer Unit c/w Internal Drawer	Base with 1 Drawer and 2 Wicker Baskets	Sink Pan Drawer Unit 1 Dummy top drawer, 1 cut out drawer option
300mm DP30 £539 (£760)	500mm PD50/4 £503 (£729)	500mm PD50/3 £418 (£609)	600mm PD60/2 £351 (£501)	600mm PDT60/2 £456	500mm WB50 £305 (£387)	900mm PDS90/3 £515
400mm DP40 £564 (£810)	600mm PD60/4 £527 (£773)	600mm PD60/3 £440 (£647)	800mm PD80/2 £400 (£579)	800mm PDT80/2 £515		2 cut out drawer option
450mm DP45 £578 (£832)	800mm PD80/4 £629 (£910)	800mm PD80/3 £518 (£761)	900mm PD90/2 £426 (£620)	900mm PDT90/2 £534		900mm PDS90/3P2 £527
500mm DP50 £588 (£849)	900mm PD90/4 £689 (£973)	900mm PD90/3 £592 (£821)	1000mm PD100/2 £478 (£641)	1000mm PDT100/2 £602	Oak option	
600mm DP60 £614 (£900)	1000mm PD100/4 £736 (£1,028)	1000mm PD100/3 £623 (£856)			500mm WB50OAK £456 (£559)	
800mm DP80 £739 (£1,058)						
900mm DP90 £787 (£1,125)						
1000mm DP100 £850 (£1,200)						

Not Contact

STANDARD WALL UNITS

Single Wall Unit	Double Wall Unit	Wall Bridging Unit	Double Wall Bridging Unit	Microwave Unit	Up & Over Flap Unit	Bi-Fold Wall Bridging Unit
Standard	Standard	600/288mm WBG60 £147	600/576mm WDBG60 £265	600/720mm WU60/MW £280	Up & Over Flap Unit	600/720mm WBF60 £394
300/720mm WU30 £130	600/720mm (c/w 2 doors) WU60/2 £207	900/288mm WBG90 £194	900/576mm WDBG90 £308		500/720mm WU50/VR £299	800/720mm WBF80 £453
400/720mm WU40 £146	800/720mm WU80 £295				600/720mm WU60/VR £318	900/720mm WBF90 £477
450/720mm WU45 £152	900/720mm WU90 £303					
500/720mm WU50 £156	1000/720mm WU100 £310					
600/720mm WU60 £175						

Note: 190mm height clearance required. No pelmet can be used if using handle suite 653.
Do not use in corner with WC60.

CORNER WALL UNITS

L Shaped Corner Wall Unit	Standard Corner Wall Unit
Standard	WC60 £250
630/630/720mm WCL630 £378	



(Price shown in brackets denotes full unit price with oak drawers)

STANDARD HEIGHT GLAZED WALL UNITS (720mm)



Standard Height Glazed Wall Unit

Aluminium Frame with Reflective Glass

c/w Reflective Glass & MFC Shelves	400mm	WG40RFL	£216	500mm	WG50RFL	£238
c/w Reflective Glass & Sirius LED Downlights	400mm	WG40RFLSIR*	£273	500mm	WG50RFLSIR*	£297
c/w Reflective Glass & Halo LED Downlights	400mm	WG40RFLLED*	£300	500mm	WG50RFLLED*	£324
c/w Reflective Glass & Edge Lit Shelves	-	-	-	500mm	WG50RFLLSH*	£331

* These glazed wall units are supplied with glass shelves

ACCESSORY BASE/WALL UNITS

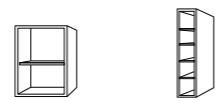

Open Unit Wine Rack

500/720/300mm WOP50	£114	150/720/300mm WR15	£72
Carcass colour only		Carcass colour only	

EURO HEIGHT UNITS



Type 1 Single Oven Housing Highline	Type 2 Single Oven Housing Drawerline	Type 3 Single Oven Housing	Type 6 Double Oven Housing	Type 8 Microwave/Steam Oven/coffee Machine Housing	Type 9 Microwave/Steam Oven/coffee Machine Housing	Type 10 Microwave/Steam Oven/coffee Machine Housing	Type 11 Microwave/Steam Oven/coffee Machine Housing	Type 1 Fridge/ Freezer Housing	Type 1 Pantry Unit
600/1492mm EOH60 T1 £243	600/1492mm EOH60 T2 £322 (£379)	c/w 3 Drawers 600/1492mm EOH60 T3 £492 (£699)	c/w 2 Drawers 600/1492mm EOH60 T6 £372 (£505)	EOH60 T8 £346 (£403)	EOH60 T9 £595 (£859)	EOH60 T10 £366 (£423) <i>Supplied with Stainless Steel filler</i>	EOH60 T11 £615 (£880) <i>Supplied with Stainless Steel filler</i>	c/w 2 Drawers 600/1492mm EPH60 T1 £462 (£595)	c/w 2 Drawers 600/1492mm EP60 T1 £473 (£605)

APPLIANCE UNITS



Tandem Larder Unit	Tandem Solo Unit	Convoy Premio Unit <i>(illus r/h)</i>	Larder Unit	Double Larder Unit	Larder Unit c/w Pull Out Wirework	Type 1 Pullout Larder Unit	Type 2 Pullout Larder Unit
500/2117mm LU50TDM £1,243	600/2117mm LU60SOLO £999	600/2117mm (L/H) LU60CONVL £1,363	300/2117mm LU30 £390	1000/2117mm LU100 £1,000	With Arena Shelves LU30A £957 LU40A £1,151 LU50A £1,267	c/w 3 Pan Drawers, 4 Internal Drawers 300/2117mm LU30P T1 £885	c/w 2 Pan Drawers, 3 Internal Drawers 300/2117mm LU30P T2 £792
with Graphite Wirework 500/2117mm LU50BTDW £1,373	with Graphite Wirework 600/2117mm LU60SOLO £1,104	600/2117mm (R/H) LU60CONVR £1,363 <i>(Please specify handing of door)</i>	400/2117mm LU40 £412		With Graphite Wirework LU30B £1,143 LU40B £1,272 LU50B £1,401	400/2117mm LU40P T1 £1,001	400/2117mm LU40P T2 £835
			500/2117mm LU50 £431			500/2117mm LU50P T1 £1,051	500/2117mm LU50P T2 £877
			600/2117mm LU60* £446				

ENGLISH ROSE CONTACT – HANDLE-LESS KITCHENS: Certain units will require a handle and are indicated by the following symbols:

- ◆ Select from face fixed handle suite 609
- ◇ Select from handle suite 653 (for use with 'English Rose Contact' aluminium extrusions) or face fixed handle suite 609
- ★ Drawer surcharge applies. Please add £45 per drawer
- ▲ Any unit with this symbol requires a 'CN' adding to the code. Please see page 80 for details

APPLIANCE AND TALL UNITS



Type 3 Larder Unit	Type 4 Larder Unit	Type 1 1000 Corner Larder to Larder	Type 2 1000 Corner Larder to Larder with Le-Mans Pull Out Storage	Type 3 1000 Corner Larder to Base
c/w 6 Internal Drawers 300/2117mm LU30P T3 £929 (£1,229)	c/w 4 Internal Drawers 300/2117mm LU30P T4 £792 (£946)	400/2117mm LUC104T1 £515	500/2117mm (L/H) LUC105T2L £1,817	400/2117mm LUC104 T3 £566
400/2117mm LU40P T3 £979 (£1,172)	400/2117mm LU40P T4 £833 (£896)	500/2117mm LUC105T1 £558	500/2117mm (R/H) LUC105T2R £1,817	500/2117mm LUC105 T3 £609
500/2117mm LU50P T3 £1,101 (£1,387)	500/2117mm LU50P T4 £874 (£1,065)	600/2117mm LUC106T1 £557	600/2117mm (L/H) LUC106T2L £1,890	600/2117mm LUC106 T3 £608
600/2117mm LU60P T3 £1,072 (£1,510)	600/2117mm LU60P T4 £857 (£1,142)		600/2117mm (R/H) LUC106T2R £1,890	

* Larder to larder units do not include a blanking panel

(Please specify handing of Le Mans) (Please specify handing)

APPLIANCE AND TALL UNITS



Type 4 1000 Corner Larder to Base with Le-Mans Pull Out Storage	1000 Butlers Larder with Wine Racks
500/2117mm (L/H) LUC105 T4L £2,074	with Graphite Wirework 500/2117mm (L/H) LUCB105 T4L £2,292
500/2117mm (R/H) LUC105 T4R £2,074	500/2117mm (R/H) LUCB105 T4R £2,292
600/2117mm (L/H) LUC106 T4L £2,144	600/2117mm (L/H) LUCB106 T4L £2,370
600/2117mm (R/H) LUC106 T4R £2,144	600/2117mm (R/H) LUCB106 T4R £2,370
<i>(Please specify handing of Le Mans)</i>	<i>(Please specify handing)</i>

Please note: This unit is only available on Lissa Oak cabinet

BUTLERS LARDER ACCESSORY ITEMS

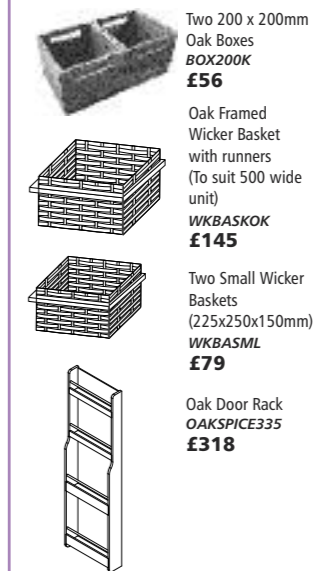

Two 200 x 200mm Oak Boxes
BOX200K
£56

Oak Framed Wicker Basket with runners (To suit 500 wide unit)
WKBASKOK
£145

Two Small Wicker Baskets (225x250x150mm)
WKBASML
£79

Oak Door Rack
OAKSPICE335
£318





Price Group 0B

Contemporary New England Oak
Contemporary White Oak
Zest Gloss White
Zest Gloss Ivory
Zest Gloss Cashmere

(Price shown in brackets denotes full unit price with oak drawers)

ENGLISH ROSE CONTACT – HANDLE-LESS KITCHENS: Certain units will require a handle and are indicated by the following symbols:

- ◆ Select from face fixed handle suite 609
- ◆ Select from handle suite 653 (for use with 'English Rose Contact' aluminium extrusions) or face fixed handle suites 609
- ★ Drawer surcharge applies. Please add £45 per drawer
- ▲ Any unit with this symbol requires a 'CN' adding to the code. Please see page 80 for details

APPLIANCE UNITS



Unit Type	Dimensions	Code	Price
Built Under Oven Housing	600mm BUOH	OH60 T1	£112
Built Under Oven Housing with drawer	600mm BUOHD	OH60 T2	£198
Type 1 Double Oven Housing	600/2117mm	OH60 T1	£368
Type 2 Double Oven Housing	c/w 2 Drawers 600/2117mm	OH60 T2	£538 (£688)
Type 3 Double Oven Housing	c/w 3 Drawers 600/2117mm	OH60 T3	£625 (£814)
Type 5 Single Oven/Microwave Unit	600/2117mm	OH60 T5	£362
Type 6 Single Oven Housing	600/2117mm	OH60 T6	£495 (£522)
Type 7 Single Oven Housing	600/2117mm	OH60 T7	£574 (£689)
Type 8 Single Oven Housing	600/2117mm	OH60 T8	£745 (£1,009)
Type 9 Microwave/Steam Oven/coffee Machine Housing	OH60 T9	£598 (£713)	
Type 10 Microwave/Steam Oven/coffee Machine Housing	OH60 T10	£535 (£685)	
Type 11 Microwave/Steam Oven/coffee Machine Housing	OH60 T11†	£555 (£705)	

APPLIANCE UNITS

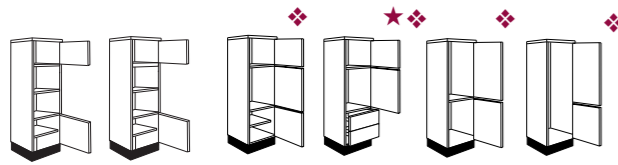

Unit Type	Dimensions	Code	Price
Type 12 Microwave/Steam Oven/coffee Machine Housing	OH60 T12	£365	
Type 13 Microwave/Steam Oven/coffee Machine Housing	OH60 T13†	£385	
Type 1 Fridge/Freezer Housing	600/2117mm	FFH60 T1	£458
Type 2 Fridge/Freezer Housing	c/w 2 Drawers 600/2117mm	FFH60 T2	£628 (£778)
Type 5 Fridge & Freezer Housing	600/2117mm	FFH60 T5	£422
Type 6 Combi Fridge/Freezer Housing	600/2117mm	FFH60 T6	£431

Please refer to fascia matrix on page 57.

† Supplied with Stainless Steel filler

INTEGRATED APPLIANCE FASCIA

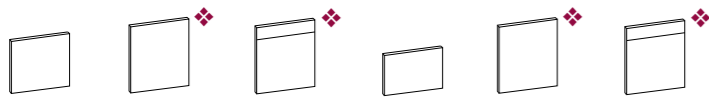

Fascia Type	Dimensions	Code	Price
Semi Integrated Dishwasher Fascia	600mm	IFS60	£50
Highline Integrated Fridge/Freezer Fascia	600mm	IF60FR	£83
Drawerline Integrated Fridge/Freezer Fascia	600mm	IFD60FR	£83
Integrated Hood Fascia	600/450mm	IF60EXT	£55
Highline Dishwasher Fascia	450mm Slimline	IF45	£68
Drawerline Dishwasher Fascia	450mm Slimline	IFD45	£72
	600mm Fully Integrated	IF60DW	£83
	600mm Fully Integrated	IFD60DW	£83



Accessories

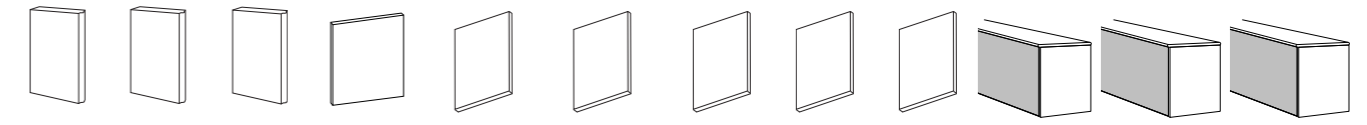

Accessory	Dimensions	Code	Price
End Support Panel/Add on Base End Panel	940 x 670	ESPMHO	£39
Graphite End Support Panel/Add on Base End Panel	940 x 670 MFC	ESP1GR	£34
Aluminium End Support Panel/Add on Base End Panel	920 x 670 MFC	ESP1AL	£34
Standard Wall Add On End Panel	760 x 375	EPWMMHO	£24
Euro Height Add On Base End Panel	1562 x 670	EPEMHO	£81
Multi Purpose Panel/Larder Add On End Panel	2400 x 670	MPPMHO	£102
Aluminium Multi Purpose Panel/Larder Add On End Panel	2347 x 670 MFC	MPP1AL	£111
Graphite Multi Purpose Panel/Larder Add On End Panel	2400 x 670 MFC	MPP1GR	£111
Dresser Add On End Panel/Two Wall Ends	1584 x 375	EPWDMHO	£40
Breakfast Bar Back Panel	940 x 2010	BBBPMHO	£102
Aluminium Breakfast Bar Back Panel	940 x 2010 MFC	BBBP1AL	£87
Graphite Breakfast Bar Back Panel	940 x 2010 MFC	BBBP1GR	£87

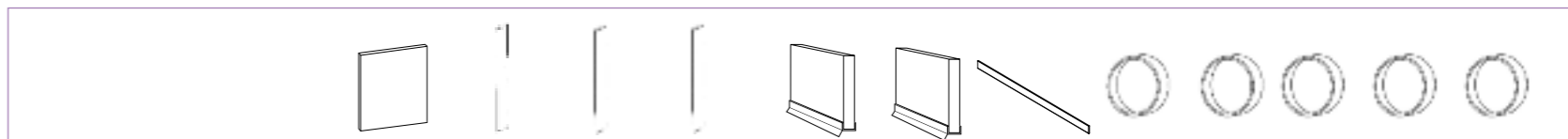

Accessory	Dimensions	Code	Price
Island End Panel	716 x 860 Supplied Horizontal Grain	IEPHORMHO	£39
100mm Wide Cornice/Pelmet/Filler	2400 x 100	TFMHO	£34
100mm Graphite Wide Cornice/Pelmet/Filler	2400 x 100 MFC	TF1GR	£30
100mm Aluminium Filler Panel - 18mm MFC - 2297mm Edged, 1 long & 2 Short		TF1AL	£30
Plinth with Seal	150 x 2750 Horizontal Grain	PLMHO	£40
Graphite Plinth with Seal	150 x 2750	PLGR	£34
Mirrored Plinth - No Seal	2650mm	PLMIR	£84
5 Metre Roll of Edging Tape	22mm x 2mm	ETSMHO	£30
10 Metre Roll of Graphite Edging Tape		ETGR	£17
10 Metre Aluminium Edging Tape - Unglued PVC		ETAL	£17
5 Metre Roll Graphite Edging Tape (1.3mm thick)		ETSGR	£26
5 Metre Aluminium Edging Tape (1.3mm thick)		ETSAL	£26

PLEASE NOTE All panels are edged on all 4 sides
Cornice/Pelmets/Pilasters are edged on 1 long and 2 short sides
Mirrored Plinths are edged on 2 long sides

(Price shown in brackets denotes full unit price with oak drawers)

Please note Tall Units are available in all Group 1 ranges.

HIGHLINE BASE UNITS

Single Base Unit	Double Base Unit	Belfast Sink Base Unit	Breakfront Unit with Shelf	Breakfront Unit with Pull Out Wirework (R/H illus)	Base Unit with 2 Pull Out Arena Shelves	Base Unit with Pull Out Chrome Wine Rack	Base with 2 Pull Out Wirework	Base Unit with 2 Pull Out Wirework and Stainless Steel Fascia	Base c/w 2 (140mm deep) Veg Baskets	Type 2 Pullout	Type 3 Pullout c/w 2 Internal Drawers
150mm BU15H £97 300mm BU30 £161 400mm BU40 £181 450mm BU45 £185 500mm BU50 £185 600mm BU60 £209	800mm BU80 £323 900mm BU90 £329 1000mm BU100 £329	600mm BEL60 £171	300mm BFR530 £197	300mm c/w Arena Shelves L/H BFR30LA £467 300mm c/w Arena Shelves R/H BFR30RA £467	300mm B30AW £392 with Graphite Wirework 300mm B30BW £433	400mm B40WRL £544 400mm B40WRR £544	150mm BU15 £267 with Graphite Wirework 150mm B15B £295	150mm BU155S £344 with Graphite Wirework 150mm B15B5S £380	400mm B40V £288 500mm B50V £308 600mm B60V £336	300mm B30PT2 £290 400mm B40PT2 £315 450mm B45PT2 £321 500mm B50PT2 £325 600mm B60PT2 £355	300mm B30PT3 £351 (£428) 400mm B40PT3 £378 (£466) 450mm B45PT3 £378 (£479) 500mm B50PT3 £393 (£488) 600mm B60PT3 £425 (£530)

HIGHLINE CORNER BASE UNITS

Base Unit with Le-Mans Pull Out Storage* (L/H illus)	Corner Base Unit* (L/H illus)	L Shaped Corner Base Unit	Corner Carousel Base Unit* (L/H illus)	Corner Base Unit c/w Vario Pull Out Storage* (R/H illus)	L Shaped Corner Carousel Base Unit	Curved L Shaped Corner Base Unit
900mm L/H c/w 450mm door BCC145ML £913 1000mm L/H c/w 500mm door BCC100ML £946 1000mm L/H c/w 600mm door BCC160ML £990 900mm R/H c/w 450mm door BCC145MR £913 1000mm R/H c/w 500mm door BCC100MR £946 1000mm R/H c/w 600mm door BCC160MR £990	with Graphite Wirework 900mm L/H c/w 450mm door BCCB145ML £1,008 1000mm L/H c/w 500mm door BCCB100ML £1,045 1000mm L/H c/w 600mm door BCCB160ML £1,094 900mm R/H c/w 450mm door BCCB145MR £1,008 1000mm R/H c/w 500mm door BCCB100MR £1,045 1000mm R/H c/w 600mm door BCCB160MR £1,094	800mm c/w 400mm door BC80 £284 900mm c/w 450mm door BC90 £290 1000mm c/w 500mm door BC100 £290 1000mm c/w 600mm door BC120 £308	930/930mm BC93 £452 1030/1030mm BC103 £507	1000mm c/w 500mm door & Arena Shelves BCC100A £675 1000mm L/H c/w Arena Shelves 450mm door BCM145LA £928 1000mm L/H c/w Arena Shelves 500mm door BCM100LA £937 1000mm L/H c/w Arena Shelves 600mm door BCM160LA £947 900mm R/H c/w Arena Shelves 450mm door BCM145RA £928 1000mm R/H c/w Arena Shelves 500mm door BCM100RA £937 1000mm R/H c/w Arena Shelves 600mm door BCM160RA £947	930/930mm c/w Arena Shelves BCC93A £796 930/930mm c/w Graphite Wirework BCC93B £880	930/930mm BCC93 £539 <i>Please note: This unit is only available in White Satin</i> <i>Only available on Gloss Stone, Gloss Ivory, Gloss White, Platinum White and Matt Ivory cabinets</i>

* Corner base units do not include a blanking panel. The end support panel ESP can be used for this purpose if required.

DRAWERLINE BASE UNITS

Single Base Unit	Double Base Unit	Base Unit 1 Dummy Drawer	Base Unit Dummy Drawer	Base Unit 2 Dummy Drawers	Breakfront Unit with Shelf	Breakfront Unit with Pull Out Wirework (R/H illus)	Base Unit with Pull Out Arena Shelves/Dummy Drawer	Base Unit with Dummy Drawer & Pull Out Wine Rack	Base c/w 2 (140mm deep) Veg Baskets	Type 1 Pullout c/w 1 Pan Drawer, 1 Internal Drawer
300mm BD30 £246 (£290) 400mm BD40 £267 (£316) 450mm BD45 £273 (£323) 500mm BD50 £274 (£327) 600mm BD60 £299 (£356)	800mm BD80 £496 (£594) 900mm BD90 £505 (£607) 1000mm BD100 £509 (£614)	800mm BSD80 £427 (£476) 900mm BSD90 £434 (£485) 1000mm BSD100 £436 (£488)	300mm BDD30 £187 400mm BDD40 £207 450mm BDD45 £211 500mm BDD50 £211 600mm BDD60 £235	800mm BDD80 £374 900mm BDD90 £380 1000mm BDD100 £380	300mm BFR530D £223	300mm c/w Arena Shelves L/H BFR30DLA £482 300mm c/w Arena Shelves R/H BFR30DRA £482	300mm BDD30AW £378 400mm BDD40WRR £515 400mm BDD40WRL £515 300mm BDD30BW £417	400mm BDD40WRR £515 400mm BDD40WRL £515	400mm BD40V £348 (£395) 500mm BD50V £370 (£419) 600mm BD60V £397 (£451)	300mm BD30PT1 £395 400mm BD40PT1 £423 450mm BD45PT1 £433 500mm BD50PT1 £439 600mm BD60PT1 £472

* Corner base units do not include a blanking panel. The end support panel ESP can be used for this purpose if required.

DRAWERLINE CORNER BASE UNITS

Corner Base Unit* (L/H illus)	L Shaped Corner Base Unit	Corner Carousel Base Unit* (L/H illus)	Corner Base Unit c/w Vario Pull Out Storage* (R/H illus)	L Shaped Corner Carousel Base Unit	Base Unit with Le-Mans Pull Out Storage* (L/H illus)
800mm c/w 400mm door BCD80 £365 (£415) 900mm c/w 450mm door BCD90 £373 (£424) 1000mm c/w 500mm door BCD100 £375 (£427) 1000mm c/w 600mm door BCD120 £394 (£451)	930/930mm BCD93 £520 1030/1030mm BCD103 £533	1000mm c/w 500mm door & Arena Shelves BCCD10A £675 (£725) 1000mm c/w 600mm door & Arena Shelves BCCD12A £691 (£745)	900mm L/H c/w 450mm door & Arena Shelves BCMD14LA £996 (£1,044) 900mm R/H c/w 450mm door & Arena Shelves BCMD14RA £996 (£1,044) 1000mm L/H c/w 500mm door & Arena Shelves BCMD10LA £1,005 (£1,054) 1000mm R/H c/w 500mm door & Arena Shelves BCMD10RA £1,005 (£1,054) 1000mm L/H c/w 600mm door & Arena Shelves BCMD16LA £1,013 (£1,067) 1000mm R/H c/w 600mm door & Arena Shelves BCMD16RA £1,013 (£1,067)	930/930mm c/w Arena Shelves BCCD93A £726 930/930mm c/w Graphite Wirework BCCD93B £803	900mm L/H c/w 450mm door BCCD14ML £912 (£960) 900mm R/H c/w 450mm door BCCD14MR £912 (£960) 1000mm L/H c/w 600mm door BCCD10ML £944 (£993) 1000mm R/H c/w 600mm door BCCD10MR £944 (£993) 1000mm L/H c/w 500mm door BCCD16ML £986 (£1,040) 1000mm R/H c/w 500mm door BCCD16MR £986 (£1,040)

* Corner base units do not include a blanking panel. The end support panel ESP can be used for this purpose if required.

ENGLISH ROSE CONTACT - HANDLE-LESS

KITCHENS: Certain units will require a handle and are indicated by the following symbols:

- ◆ Select from face fixed handle suite 609
- ◆ Select from handle suite 653 (for use with 'English Rose Contact' aluminium extrusions) or face fixed handle suite 609
- * Drawer surcharge applies. Please add £45 per drawer
- ▲ Any unit with this symbol requires a 'CN' adding to the code. Please see page 80 for details

DRAWER PACK UNITS

5 Drawer Pack	4 Pan Drawer Pack	3 Pan Drawer Pack	2 Drawer Unit	2 Drawer Unit c/w Internal Drawer	Base with 1 Drawer and 2 Wicker Baskets	Sink Pan Drawer Unit 1 Dummy drawer, 1 Cut out drawer option
300mm DP30 £571 (£793) 400mm DP40 £609 (£855) 450mm DP45 £623 (£877) 500mm DP50 £632 (£894) 600mm DP60 £666 (£953) 800mm DP80* £833 (£1,151) 900mm DP90 £865 (£1,204) 1000mm DP100* £933 (£1,284)	500mm PD50/4 £544 (£771) 600mm PD60/4 £575 (£821) 800mm PD80/4* £708 (£989) 900mm PD90/4 £761 (£1,045) 1000mm PD100/4* £812 (£1,104)	500mm PD50/3 £457 (£648) 600mm PD60/3 £483 (£690) 800mm PD80/3* £582 (£826) 900mm PD90/3 £656 (£886) 1000mm PD100/3* £692 (£925)	600mm PD60/2 £376 (£525) 800mm PD80/2 £425 (£604) 900mm PD90/2 £456 (£617) 1000mm PD100/2 £504 (£667)	600mm PDT60/2 £476 800mm PDT80/2 £535 900mm PDT90/2 £569 1000mm PDT100/2 £622	500mm WB50 £317 (£367) Oak option 500mm WB50/OAK £472 (£521)	900mm PDS90/3 £583 2 Cut out drawer option 900mm PDS90/3P2 £594 <i>Not Contact</i>

* Only available in Shaker Lissa Oak, Shaker Ivory, Shaker Sand Oak, White Satin & Ivory Prelude. Only available in White Satin, Shaker Lissa Oak & Ivory Prelude.

CURVED END BASE UNIT

Curved End Base Unit	Single Base Unit
300mm c/w 1 door & 1 shelf CEB301 £488 <i>Please note: This unit is only available in White Satin, Shaker Lissa, Sand Oak, Shaker Ivory & Ivory Prelude.</i>	260mm Base Unit BU26 £151 <i>Please note: This unit is only available in White Satin, Shaker Lissa, Sand Oak & Ivory Prelude.</i>

Please refer to special workshop planning guidelines on page 90.



STANDARD & TALL WALL UNITS

Single Wall Unit	Double Wall Unit	Wall Bridging Unit	Double Wall Bridging Unit	Microwave Unit	Up & Over Flap Unit	Bi-Fold Wall Bridging Unit
Standard 150/720mm WU15 £119 300/720mm WU30 £147 400/720mm WU40 £167 450/720mm WU45 £173 500/720mm WU50 £177 600/720mm WU60 £200	Tall 300/900mm TWU30 £159 400/900mm TWU40 £180 450/900mm TWU45 £186 500/900mm TWU50 £190 600/900mm TWU60 £234	Standard 600/720mm (c/w 2 doors) WU60/2 £238 800/720mm WU80 £336 900/720mm WU90 £345 1000/720mm WU100 £353	Tall 600/900mm (c/w 2 doors) TWU60/2 £253 800/900mm TWU80 £356 900/900mm TWU90 £365 1000/900mm TWU100 £376	600/288mm WBG60 £170 900/288mm WBG90 £230	600/576mm WDBG60 £310 900/576mm WDBG90 £377	600/720mm WU60/MW £307 500/720mm WU50/VR £325 600/720mm WU60/VR £348 900/720mm WU90/VR £348

Note: 190mm height clearance required. No pelmet can be used if using handle suite 653. Do not use in corner with WC60. This unit is only available in Shaker Lissa Oak, Shaker Ivory, Shaker Sand Oak, White Satin & Ivory Prelude.

CORNER WALL UNITS

L Shaped Corner Wall Unit	Standard Corner Wall Unit
Standard 630/630/720mm WCL630 £382	WC60 £262
Tall 630/630/900mm TWCL630 £475	

CURVED WALL END UNIT

260mm Wall Unit	Curved End Wall Unit	L Curved Internal Wall Unit
260/720mm c/w 1 door & 1 adjustable shelf WU26 £157	300/300mm c/w 1 door & 1 adjustable shelf CEW301 £503	670/670mm c/w 1 door & 2 adjustable shelves WCCU67 £550
<i>Please note: This unit is only available White Satin, Shaker Lissa, Sand Oak & Ivory Prelude.</i>	<i>Please note: CEW301 is only available White Satin, Shaker Lissa Oak, Shaker Sand Oak & Ivory Prelude. TCEW301 is only available in White Satin.</i>	<i>Please note: This unit is only available White Satin. Only available on Gloss Stone, Gloss Ivory, Gloss White, Platinum White and Matt Ivory cabinets. Please refer to special planning guidelines on page 78.</i>

(Price shown in brackets denotes full unit price with oak drawers)

Please note Tall Units are available in all Group 1 ranges.

STANDARD HEIGHT GLAZED WALL UNITS (1720mm)

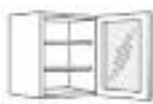

Standard Height Glazed Wall Unit

Range Specific Frames with Clear Glass						
Standard Glass Unit & MFC Shelves	400mm	WG40*	£201	500mm	WG50*	£219
c/w Sirius LED Lights & Glass Shelves	400mm	WG40SIR*	£270	500mm	WG50SIR*	£289
c/w Halo LED Downlights	400mm	WG40LED*	£302	500mm	WG50LED*	£322
c/w Edge Lit Shelves	-	-	-	500mm	WG50LSH*	£330
Aluminium Frame with Reflective Glass						
c/w Reflective Glass & MFC Shelves	400mm	WG40RFL	£216	500mm	WG50RFL	£238
c/w Reflective Glass & Sirius LED Downlights	400mm	WG40RFLSIR*	£273	500mm	WG50RFLSIR*	£297
c/w Reflective Glass & Halo LED Downlights	400mm	WG40RFLLED*	£300	500mm	WG50RFLLED*	£324
c/w Reflective Glass & Edge Lit Shelves	-	-	-	500mm	WG50RFLSH*	£331

* Not in White Satin ♦ These glazed wall units are supplied with glass shelves

TALL HEIGHT GLAZED WALL UNITS (900mm)

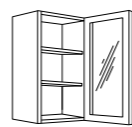

Tall Height Glazed Wall Unit

Please note: These units are only available in Ivory Prelude, Ivory Shaker & Shaker Sand Oak

Range Specific Frames with Clear Glass						
Standard Tall Glass Unit & MFC Shelves	500mm	TWG50	£234			
c/w Sirius LED Lights & Glass Shelves	500mm	TWG50SIR*	£304			
c/w Halo LED Downlights	500mm	TWG50LED*	£337			
c/w Edge Lit Shelves	500mm	TWG50LSH*	£349			
Aluminium Frame with Reflective Glass (available in all ranges)						
c/w Reflective Glass & MFC Shelves	500mm	TWG50RFL	£263			
c/w Reflective Glass & Sirius LED Downlights	500mm	TWG50RFLSIR*	£315			
c/w Reflective Glass & Halo LED Downlights	500mm	TWG50RFLLED*	£349			
c/w Reflective Glass & Edge Lit Shelves	500mm	TWG50RFLSH*	£356			

♦ These glazed wall units are supplied with glass shelves

DRESSER HEIGHT GLAZED WALL UNITS (1207mm)



Dresser Height Glazed Unit

Range Specific Frames with Clear Glass					
Standard Dresser Glazed Unit & MFC Shelves	500mm	DR50*	£271		
c/w Sirius LED Lights & Glass Shelves	500mm	DR50SIR*	£374		
c/w Halo LED Downlights	500mm	DR50LED*	£402		
c/w Edge Lit Shelves	500mm	DR50LSH*	£474		

* Not available in White Satin ♦ These glazed wall units are supplied with glass shelves

Please refer to page 62 for illustrations of range specific glazed doors



ACCESSORY BASE/WALL UNITS

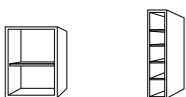

Open Unit	Wine Rack
500/720/300mm WOP50 £114	Standard 150/720/300mm WR15 £72 Tall 150/900/300mm TWR15 £80

EURO HEIGHT UNITS



Type 1 Single Oven Housing Highline	Type 2 Single Oven Housing Drawerline	Type 3 Single Oven Housing	Type 6 Double Oven Housing	Type 8 Microwave/Steam Oven/coffee Machine Housing	Type 9 Microwave/Steam Oven/coffee Machine Housing	Type 10 Microwave/Steam Oven/coffee Machine Housing	Type 11 Microwave/Steam Oven/coffee Machine Housing	Type 1 Fridge/Freezer Housing	Type 1 Pantry Unit
600/1492mm EOH60 T1 £261	600/1492mm EOH60 T2 £349 (£406)	c/w 3 Drawers EOH60 T3 £533 (£740)	c/w 2 Drawers 600/1492mm EOH60 T6 £395 (£527)	EOH60 T8 £364 (£421)	EOH60 T9 £648 (£912)	EOH60 T10 £383 (£440) <i>Supplied with Stainless Steel filler</i>	EOH60 T11 £667 (£931) <i>Supplied with Stainless Steel filler</i>	c/w 2 Drawers 600/1492mm EPH60 T1 £515 (£647)	c/w 2 Drawers 600/1492mm EP60 T1 £525 (£657)

ENGLISH ROSE CONTACT – HANDLE-LESS KITCHENS: Certain units will require a handle and are indicated by the following symbols:

- ♦ Select from face fixed handle suite 609
- ♦ Select from handle suite 653 (for use with 'English Rose Contact' aluminium extrusions) or face fixed handle suite 609
- ♦ Drawer surcharge applies. Please add £45 per drawer
- ▲ Any unit with this symbol requires a 'CN' adding to the code. Please see page 80 for details

APPLIANCE AND TALL UNITS

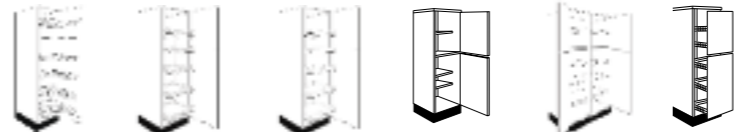

Tandem Larder Unit	Tandem Solo Unit	Convoy Premio Unit (illus r/h)	Larder Unit	Double Larder Unit	Larder Unit c/w Pull Out Wirework	Type 1 Pullout Larder Unit	Type 2 Pullout Larder Unit	
500/2117mm LUS0TDM £1,281	600/2117mm LUG0SOLO £1,052	600/2117mm (L/H) LUG0CONVL £1,416 600/2117mm (R/H) LUG0CONVR £1,416	300/2117mm LU30 £432 400/2117mm LU40 £460 500/2117mm LU50 £488 600/2117mm LU60 £507	1000/2117mm LU100 £1,060	With Arena Shelves Standard 300/2117mm LUS0A £1,076 400/2117mm LU40A £1,199 500/2117mm LUS0A £1,324 Tall 300/2297mm TLU30A £1,120 400/2297mm TLU40A £1,249 500/2297mm TLU50A £1,379	With Graphite Wirework Standard 300/2117mm LUS0B £1,189 400/2117mm LU40B £1,325 500/2117mm LUS0B £1,463 Tall 300/2297mm TLU30B £1,238 400/2297mm TLU40B £1,380 500/2297mm TLU50B £1,524	c/w 3 Pan Drawers, 4 Internal Drawers Standard 300/2117mm LU30P T1 £947 400/2117mm LU40P T1 £1,003 500/2117mm LU50P T1 £1,057 Tall 300/2297mm TLU30P T1 £967 400/2297mm TLU40P T1 £1,022 500/2297mm TLU50P T1 £1,078	c/w 2 Pan Drawers, 3 Internal Drawers Standard 300/2117mm LU30P T2 £796 400/2117mm LU40P T2 £844 500/2117mm LU50P T2 £891 Tall 300/2297mm TLU30P T2 £816 400/2297mm TLU40P T2 £864 500/2297mm TLU50P T2 £911

APPLIANCE AND TALL UNITS



Type 3 Larder Unit	Type 4 Larder Unit	Type 1 1000 Corner Larder to Larder	Type 2 1000 Corner Larder to Larder with Le-Mans Pull Out Storage
c/w 6 Internal Drawers Standard 300/2117mm LU30P T3 £993 (£1,224) 400/2117mm LU40P T3 £1,049 (£1,172) 500/2117mm LU50P T3 £1,105 (£1,391) 600/2117mm LU60P T3 £1,109 (£1,424)	Tall 300/2297mm TLU30P T3 £1,013 (£1,243) 400/2297mm TLU40P T3 £1,070 (£1,332) 500/2297mm TLU50P T3 £1,125 (£1,411) 600/2297mm TLU60P T3 £1,118	c/w 4 Internal Drawers Standard 300/2117mm LU30P T4 £797 (£950) 400/2297mm LU40P T4 £843 (£896) 500/2297mm LU50P T4 £889 (£1,079) 600/2117mm LU60P T4 £908 (£1,118)	400/2117mm LUC104T1 £590 500/2117mm LUC105T1 £616 600/2117mm LUC106T1 £655 Tall 400/2297mm LUC104T1 £626 500/2297mm LUC105T1 £657 500/2117mm (L/H) LUC105T2L £1,878 500/2117mm (R/H) LUC105T2R £1,878 600/2117mm (L/H) LUC106T2L £1,963 600/2117mm (R/H) LUC106T2R £1,963 Tall 500/2297mm (L/H) TLUC105T2L £1,905 500/2297mm (R/H) TLUC105T2R £1,905 with Graphite Wirework 500/2117mm (L/H) LUCB105T2L £2,075 500/2117mm (R/H) LUCB105T2R £2,075 600/2117mm (L/H) LUCB106T2L £2,169 600/2117mm (R/H) LUCB106T2R £2,169 Tall 500/2297mm (L/H) TLUCB105T2L £2,106 500/2297mm (R/H) TLUCB105T2R £2,106

* Larder to larder units do not include a blanking panel

(Please specify handling of Le Mans)

APPLIANCE AND TALL UNITS



Type 3 1000 Corner Larder to Base	Type 4 1000 Corner Larder to Base with Le-Mans Pull Out Storage	1000 Butlers Larder with Wine Racks
400/2117mm TLUC104 T3 £840 500/2117mm LUC105 T3 £868 600/2117mm LUC106 T3 £898 Tall 400/2297mm TLUC104 T3 £869 500/2297mm TLUC105 T3 £900	500/2117mm (L/H) LUC105 T4L £2,099 500/2117mm (R/H) LUC105 T4R £2,099 600/2117mm (L/H) LUC106 T4L £2,185 600/2117mm (R/H) LUC106 T4R £2,185 Tall 500/2297mm (L/H) TLUC105 T4L £2,128 500/2297mm (R/H) TLUC105 T4R £2,351 with Graphite Wirework 500/2117mm (L/H) LUCB105 T4L £2,320 500/2117mm (R/H) LUCB105 T4R £2,320 600/2117mm (L/H) LUCB106 T4L £2,415 600/2117mm (R/H) LUCB106 T4R £2,415 Tall 500/2297mm (L/H) TLUCB105 T4L £2,351 500/2297mm (R/H) TLUCB105 T4R £2,351 Please note: This unit is only available on Lissa Oak cabinet	1000/2117mm LU100BUT £1,107 1000/2297mm TLU100BUT £1,156

BUTLERS LARDER ACCESSORY ITEMS

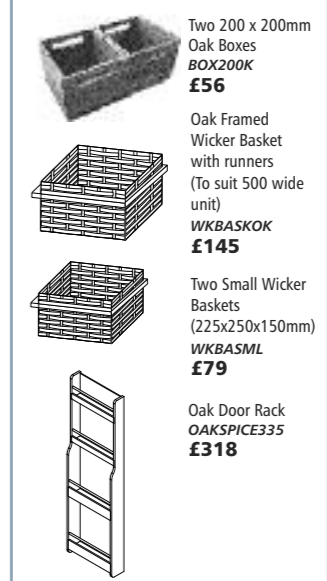

Two 200 x 200mm Oak Boxes
BOX200K
£56

Oak Framed Wicker Basket with runners (To suit 500 wide unit)
WKBASKOK
£145

Two Small Wicker Baskets (225x250x150mm)
WKBASML
£79

Oak Door Rack
OAKSPICE335
£318

APPLIANCE AND TALL UNITS



Built Under Oven Housing	Built Under Oven Housing with drawer	Type 1 Double Oven Housing	Type 2 Double Oven Housing	Type 3 Double Oven Housing	Type 5 Single Oven/Microwave Unit	Type 6 Single Oven Housing	Type 7 Single Oven Housing	Type 8 Single Oven Housing	Type 9 Microwave/Steam Oven/coffee Machine Housing	Type 10 Microwave/Steam Oven/coffee Machine Housing	Type 11 Microwave/Steam Oven/coffee Machine Housing
600mm BUOH £116	600mm BUOHD £198	600/2117mm OH60 T1 £416	c/w 2 Drawers 600/2117mm OH60 T2 £581 (£731) Tall 600/2297mm TOH60 T1 £434	c/w 3 Drawers 600/2117mm OH60 T3 £673 (£862) Tall 600/2297mm TOH60 T2 £598 (£748)	600/2117mm OH60 T5 £402 Tall 600/2297mm TOH60 T5 £434	600/2117mm OH60 T6 £527 (£584) Tall 600/2297mm TOH60 T6 £544 (£601)	600/2117mm OH60 T7 £627 (£741) Tall 600/2297mm TOH60 T7 £644 (£758)	600/2117mm OH60 T8 £811 (£1,075) Tall 600/2297mm TOH60 T8 £828 (£1,092)	OH60 T9 £642 (£756) Tall 600/2297mm TOH60 T9 £659 (£773)	OH60 T10 £578 (£728) Tall 600/2297mm TOH60 T10† £634 (£783)	OH60 T11† £597 (£747) Tall 600/2297mm TOH60 T11 £636 (£786)

† Supplied with Stainless Steel filler

APPLIANCE AND TALL UNITS



Type 12 Microwave/Steam Oven/coffee Machine Housing	Type 13 Microwave/Steam Oven/coffee Machine Housing	Type 1 Fridge/Freezer Housing	Type 2 Fridge/Freezer Housing	Type 5 Fridge & Freezer Housing	Type 6 Combi Fridge/Freezer Housing (Tall unit illustrated)	Type 8 Combi Fridge/Freezer Housing
OH60 T12 £412 Tall 600/2297mm TOH60 T12† £471	OH60 T13† £432 Tall 600/2297mm TOH60 T13 £474	600/2117mm FFH60 T1 £541 Tall 600/2297mm TFFH60 T1 £559	c/w 2 Drawers 600/2117mm FFH60 T2 £701 (£851) Tall 600/2297mm TFFH60 T2 £718 (£868)	600/2117mm FFH60 T5 £496 Tall 600/2297mm TFFH60 T5 £538	600/2117mm FFH60 T6 £496	Tall* 600/2297mm TFFH60 T8 £548

† Supplied with Stainless Steel filler

* Please refer to fascia matrix on page 69 & page 99 for layout of doors.

INTEGRATED APPLIANCE FASCIAS

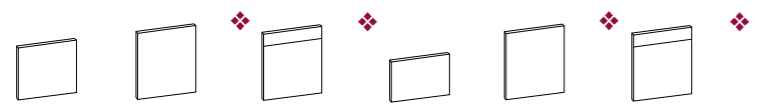

Semi Integrated Dishwasher Fascia	Highline Integrated Fridge/Freezer Fascia	Drawerline Integrated Fridge/Freezer Fascia	Integrated Hood Fascia	Highline Dishwasher Fascia	Drawerline Dishwasher Fascia
600/572mm IFS60 £77	600mm IF60FR £101	600mm IFD60FR £127	600/450mm IF60EXT £76	450mm Slimline IF45 £83 600mm Fully Integrated IF60DW £101	450mm Slimline IFD45 £109 600mm Fully Integrated IFD60DW £127



Cornice & Pelmet

	Traditional Cornice PVC Wrapped (H - 56mm)		Traditional Pelmet PVC Wrapped (H - 60mm)		Traditional Cornice Foil Wrapped (H - 70mm)		Square section Cornice/Pelmet/Plaster (H - 36mm)		Curved Cornice/Pelmet (H - 36mm) External	Internal Curved Section (H-36mm) Square
	1750mm	3600mm	1750mm	3600mm	1750mm	3600mm	1750mm	3600mm		
White Satin							CBPVCMMW £66	CBPVCMMW £102	CBCVMW £126	CBCIMW £126
Ivory Shaker			TCFWPIVH £47	TCFWPIV £84			CBFWPIVH £36	CBFWPIV £69	CBCVFIW £126	
Shaker Lissa Oak			TCFWPLAH £47	TCFWPLA £84			CBFWPLAH £36	CBFWPLA £69	CBCVLF £126	
Regent Ivory	TCPVCVYH £47	TCPVCVY £84	LPPVCVYH £38	LPPVCVY £77			CBPVCVYH £66	CBPVCVY £102		
Shaker Sand Oak					TCFWPSFH £47	TCFWPSF £84	CBFWPSFH £36	CBFWPSF £69	CBCVSF £126	
Ivory Prelude	TCPVCVYH £47	TCPVCVY £84	LPPVCVYH £38	LPPVCVY £77			CBPVCVYH £66	CBPVCVY £102	CBCVVY £126	
Moda White							CBPVCWTEH £66	CBPVCWTE £102		
Moda Ivory							CBPVCIVRH £66	CBPVCIVR £102		
Moda Cashmere							CBPVCASH £66	CBPVCAS £102		
Moda Light Grey							CBPVCGRYH £66	CBPVCGRY £102		
Grooved Ivory	TCPVCVYH £47	TCPVCVY £84	LPPVCVYH £38	LPPVCVY £77			CBPVCVYH £66	CBPVCVY £102		

Decorative Accessories	Base Corner Pilaster Painted (h920 w100)	Pilaster Painted (h920 w75)	Canopy † (Plain finish) (640 x 1105mm - can be cut down to 460 x 850mm)
White Satin			
Ivory Shaker			
Shaker Lissa Oak			
Regent Ivory	BCFDV/1 £307	PILBMATDV/1 £174	CANOPYMATDV £550
Shaker Sand Oak			
Ivory Prelude	BCFDV/1 £307	PILBMATDV/1 £174	CANOPYMATDV £550
Moda White			
Moda Ivory			
Moda Cashmere			
Moda Light Grey			
Grooved Ivory	BCFDV/1 £307	PILBMATDV/1 £174	CANOPYMATDV £550

† Can take extractor flange size 380 x 730mm

2650mm Plinth (15mm MFC) Supplied with sealing strip	2650mm Plinth (16mm MFC) Aluminium effect	Graphite Plinth with Seal 150 x 2750	3000mm Plinth Wrapped Foil	2550mm Plinth PVC Wrapped (Ivory Prelude 3000mm)	2650mm Mirrored Plinth	Curved External Mirrored Plinth	Curved Internal Mirrored Plinth	Curved Plinth PVC External	Curved Plinth Foil External	Plinth Internal Curved Section PVC	100mm Filler Panels 18mm MFC - 2297mm Edged 1 Long & 2 Short	100mm Graphite Wide Cornice/Pelmet/Filler 2400 x 100 1 Long & 2 Short MFC	100mm Filler Panels 18mm Aluminium - 2297mm Edged 1 Long & 2 Short	
Plinths														
White Satin	PLWH £34	PLAL £34	PLGR £34		PLPVCMW £107	PLMIR £84	PLCMIR £183	PLCV93MIR £175	PLCMW £104		PLCV93MW £130	TFMWS** £30	TF1GR £30	TF1AL £30
Ivory Shaker	PLIV £34	PLAL £34	PLGR £34	PLFWPIV £77		PLMIR £84	PLCMIR £183			PLCVFIV £104		TFMIS** £30	TF1GR £30	TF1AL £30
Shaker Lissa Oak	PLLA £34	PLAL £34	PLGR £34	PLFWPLA £77		PLMIR £84	PLCMIR £183			PLCVLF £104		TF1LA £30	TF1GR £30	TF1AL £30
Regent Ivory	PLIV £34	PLAL £34	PLGR £34			PLMIR £84						TFMIS** £30	TF1GR £30	TF1AL £30
Shaker Sand Oak	PLSO £34	PLAL £34	PLGR £34	PLFWPSF £77		PLMIR £84	PLCMIR £183			PLCVSF £104		TFMSO** £30	TF1GR £30	TF1AL £30
Ivory Prelude	PLIV £34	PLAL £34	PLGR £34		PLPVCVY £87	PLMIR £84			PLCVVY £104			TFMIS** £30	TF1GR £30	TF1AL £30
Moda*	PL* £34	PLAL £34	PLGR £34			PLMIR £84						TFM** £30	TF1GR £30	TF1AL £30
Grooved Ivory	PLIV £34	PLAL £34	PLGR £34			PLMIR £84						TFMIS** £30	TF1GR £30	TF1AL £30

* Moda Plinth = (WH) White, (IV) Ivory, (MLS) Light Grey, (CM) Cashmere (▲ = Curved Plinth sections for use with PVC & Foil Wrapped Plinths only) **These panels are 2400mm long

End Support Panel 920 x 670 MFC	End Support Panel 920 x 670 Aluminium	End Support Panel 920 x 670 PVC Matt	Plain Add On Panel 890 x 670 Foil Wrapped Wood Grain	Planked Add on Panel 890 x 670 Painted, Profiled front edge	Island End Panel 716 x 860	End Support Panel/Add on Wall End Panel 760 x 375 MFC	Graphite End Support Panel/Add on Base End Panel 940 x 670 MFC	Plain Add On Wall End Panel 1584 x 375 Foil Wrapped Wood Grain/MFC	End Support Panel/Add on Tall Wall End Panel 940 x 375 MFC	Planked Add on Wall End Panel 1584 x 375 Painted, Profiled front edge	End Support Panel/Add on Euro Height End Panel 1562 x 670 MFC	Plain Add On Housing End Panel 2347 x 670 Foil Wrapped Wood Grain	Planked Add on Housing End Panel 2400 x 670 Painted, Profiled front edge	Graphite Multi Purpose Panel/Larder Add On End Panel 2400 x 670 MFC
Panels														
White Satin	ESPMWS £34	ESP1AL £34	ESP1AL £34		IEPPVCMW £65	ESP1GR £34		EPFVWVIV £100						MPP1GR £111
Ivory Shaker	ESPMIS £34	ESP1AL £34		ESPFPBIV £100		ESP1GR £34				EPFVWVIV £100				MPP1GR £111
Shaker Lissa Oak	ESP1LA £34	ESP1AL £34				ESP1GR £34								MPP1GR £111
Regent Ivory	ESPMIS £34	ESP1AL £34		ESPPLKBDV/1 £115		ESP1GR £34			EPPLKWDV/1 £115			EPPLKHDV/1 £293		MPP1GR £111
Shaker Sand Oak	ESPMIS £34	ESP1AL £34				ESP1GR £34								MPP1GR £111
Ivory Prelude	ESPMIS £34	ESP1AL £34		ESPPLKBDV/1 £115		ESP1GR £34			EPPLKWDV/1 £115			EPPLKHDV/1 £293		MPP1GR £111
Moda*	ESPM* £34	ESP1AL £34				EPWMM* £21		EPWDM* £40	EPWTM* £25		EPWM* £70			MPP1GR £111
Grooved Ivory	ESPMIS £34	ESP1AL £34		ESPPLKBDV/1 £115		ESP1GR £34			EPPLKWDV/1 £115			EPPLKHDV/1 £293		MPP1GR £111

Multi Purpose Panel 2347 x 670 MFC	Multi Purpose Panel 2347 x 670 Aluminium	Multi Purpose Panel 2347 x 670 PVC Matt	Breakfast Bar Back Panel 890 x 2010 MFC (Edged 1L, 1S)	Breakfast Bar Back Panel 940 x 2010 Aluminium (Edged 1L, 1S)	Breakfast Bar Back Panel 890 x 2050 PVC Matt	Graphite Breakfast Bar Back Panel 940 x 2010 MFC	Breakfast Bar Back Panel 890 x 2050 Foil Wrapped Wood Grain 2 pieces	Planked Breakfast Bar Back Panel 890 x 2050 Painted 2 pieces	Edging Tape 10m PVC Unglued	10 Metre Roll of Graphite Edging Tape	Edging Tape 5m PVC Unglued (1.3mm thick)	10 Metre Aluminium Edging Tape - Unglued PVC	5 Metre Roll Graphite Edging Tape (1.3mm thick)	5 Metre Aluminium Edging Tape - Unglued PVC (1.3mm thick)
Panels cont'd														
White Satin	MPPMWS £111	MPP1AL £111	MPPVCMW £271	BBBPMWS £88	BBBP1AL £87	BBBPPVCMW £316	BBBP1GR £87		ETWH £17	ETGR £17	ETSWWS £26	ETAL £17	ETSGR £26	ETSA £26
Ivory Shaker	MPPMIS £111	MPP1AL £111		BBBP1IV £88	BBBP1AL £87		BBBP1GR £87	BBBPFVIV £211	ETIV £17	ETGR £17	ETSMIS £26	ETAL £17	ETSGR £26	ETSA £26
Shaker Lissa Oak	MPP1LA £111	MPP1AL £111		BBBP1LA £88	BBBP1AL £87		BBBP1GR £87		ETLA £17	ETGR £17	ETSLA £26	ETAL £17	ETSGR £26	ETSA £26
Regent Ivory	MPPMIS £111	MPP1AL £111		BBBPMIS £88	BBBP1AL £87		BBBP1GR £87	BBBPLKDV/1 £316	ETIV £17	ETGR £17	ETSMIS £26	ETAL £17	ETSGR £26	ETSA £26
Shaker Sand Oak	MPPMSO £111	MPP1AL £111		BBBPMIS £88	BBBP1AL £87		BBBP1GR £87		ETSO £17	ETGR £17	ETSMO £26	ETAL £17	ETSGR £26	ETSA £26
Ivory Prelude	MPPMIS £111	MPP1AL £111		BBBPMIS £88	BBBP1AL £87		BBBP1GR £87	BBBPLKDV/1 £316	ETIV £17	ETGR £17	ETSMIS £26	ETAL £17	ETSGR £26	ETSA £26
Moda*	MPPM* £111	MPP1AL £111		BBBPM* £88	BBBP1AL £87		BBBP1GR £87		ETSM* £17	ETGR £17	ETSM* £26	ETAL £17	ETSGR £26	ETSA £26
Grooved Ivory	MPPMIS £111	MPP1AL £111		BBBPMIS £88	BBBP1AL £87		BBBP1GR £87	BBBPLKDV/1 £316	ETIV £17	ETGR £17	ETSMIS £26	ETAL £17	ETSGR £26	ETSA £26

* Use colour code suffix to specify the colour of your accessory Moda = (LS) light Grey, (IS) Ivory, (CS) Cashmere, (WS) White

150mm BU15H £98	800mm BU80 £341	600mm BEL60 £180	300mm BFR530 £205	300mm c/w Arena Shelves L/H BFR30LA £471	300mm B30AW £406	400mm B40WRL £557	150mm BU15 £269	150mm BU15SS £344	400mm B40V £303	300mm B30PT2 £304	300mm B30PT3 £365 (£441)
300mm BU30 £171	900mm BU90 £347			300mm c/w Arena Shelves R/H BFR30RA £471	with Graphite Wirework 300mm B30BW £448	B40WRR £557	with Graphite Wirework 150mm BU15B £297	with Graphite Wirework 150mm BU15BSS £380	500mm B50V £323	400mm B40PT2 £329	400mm B40PT3 £392 (£479)
400mm BU40 £189	1000mm BU100 £347			300mm c/w Arena Shelves R/H BFR30RA £471					600mm B60V £349	450mm B45PT2 £335	450mm B45PT3 £401 (£492)
450mm BU45 £193										500mm B50PT2 £339	500mm B50PT3 £406 (£502)
500mm BU50 £193										600mm B60PT2 £367	600mm B60PT3 £436 (£541)
600mm BU60 £214											

900mm L/H c/w 450mm door BCC145ML £922	800mm c/w 400mm door BC80 £288	930/930mm BC93 £464	1000mm c/w 500mm door & Arena Shelves BCC100A £681	900mm L/H c/w Arena Shelves 450mm door BCM145LA £931	930/930mm c/w Arena Shelves BCC93A £802	930/930mm BCCU93 £541	930/930mm BCCU93/SHK £541
1000mm L/H c/w 500mm door BCC100ML £954	900mm c/w 450mm door BC90 £293	1030/1030mm BC103 £517	1000mm c/w 600mm door & Arena Shelves BCC120A £681	1000mm L/H c/w Arena Shelves 500mm door BCM100LA £940	930/930mm c/w Graphite Wirework BCC93B £886		
1000mm L/H c/w 600mm door BCC160ML £996	1000mm L/H c/w 600mm door BCC160ML £1,101		1000mm c/w 600mm door & Arena Shelves BCC120A £681	1000mm L/H c/w Arena Shelves 600mm door BCM160LA £951			
900mm R/H c/w 450mm door BCC145MR £922	900mm R/H c/w 450mm door BCC145MR £1,018		1000mm c/w 600mm door BC120 £309	900mm R/H c/w Arena Shelves 450mm door BCM145RA £931			
1000mm R/H c/w 500mm door BCC100MR £954	1000mm R/H c/w 500mm door BCC100MR £1,055			1000mm R/H c/w Arena Shelves 500mm door BCM100RA £940			
1000mm R/H c/w 600mm door BCC160MR £996	1000mm R/H c/w 600mm door BCC160MR £1,101			1000mm R/H c/w Arena Shelves 600mm door BCM160RA £951			

300mm BD30 £257 (£301)	800mm BD80 £511 (£609)	800mm BSD80 £444 (£494)	300mm BDD30 £207	800mm BDD80 £408	300mm BFR530D £240	300mm c/w Arena Shelves L/H BFR30DLA £487	300mm BDD30AW £393	400mm BDD40WRR £527	400mm BD40V £362 (£408)	300mm BD30PT1 £412
400mm BD40 £274 (£323)	900mm BD90 £520 (£622)	900mm BSD90 £452 (£502)	400mm BDD40 £223	900mm BDD90 £413		300mm c/w Arena Shelves R/H BFR30DRA £487	with Graphite Wirework 300mm BDD30BW £435	400mm BDD40WRL £527	500mm BD50V £384 (£434)	400mm BD40PT1 £436
450mm BD45 £279 (£330)	1000mm BD100 £526 (£631)	1000mm BSD100 £456 (£509)	450mm BDD45 £227	1000mm BDD100 £417					600mm BD60V £414 (£468)	450mm BD45PT1 £446
500mm BD50 £282 (£335)			500mm BDD50 £229							500mm BD50PT1 £454
600mm BD60 £309 (£366)			600mm BDD60 £256							600mm BD60PT1 £489

800mm c/w 400mm door BCD80 £369 (£418)	930/930mm BCD93 £535	1000mm c/w 500mm door & Arena Shelves BCCD10A £681 (£730)	900mm L/H c/w 450mm door & Arena Shelves BCMD14LA £999 (£1,047)	1000mm L/H c/w 500mm door & Arena Shelves BCCD10LA £1,008 (£1,058)	900mm L/H c/w 450mm door BCCD14ML £920 (£968)
900mm c/w 450mm door BCD90 £376 (£427)	1030/1030mm BCD103 £547	1000mm c/w 600mm door & Arena Shelves BCCD12A £697 (£751)	900mm R/H c/w 450mm door & Arena Shelves BCMD14RA £999 (£1,047)	1000mm R/H c/w 500mm door & Arena Shelves BCCD10RA £1,008 (£1,058)	900mm R/H c/w 450mm door BCCD14MR £920 (£968)
1000mm c/w 500mm door BCD100 £379 (£431)			1000mm R/H c/w 500mm door & Arena Shelves BCMD10RA £1,008 (£1,058)	1000mm R/H c/w 600mm door & Arena Shelves BCCD16RA £1,019 (£1,073)	900mm R/H c/w 450mm door BCCD14MR £920 (£968)
1000mm c/w 600mm door BCD120 £400 (£457)					1000mm L/H c/w 600mm door BCCD10ML £953 (£1,002)
					1000mm R/H c/w 600mm door BCCD10MR £953 (£1,002)
					1000mm L/H c/w 500mm door BCCD16ML £997 (£1,051)
					1000mm R/H c/w 500mm door BCCD16MR £997 (£1,051)

(Price shown in brackets denotes full unit price with oak drawers) Please note Tall Units are available in all Group 2 ranges.

ENGLISH ROSE CONTACT – HANDLE-LESS KITCHENS: Certain units will require a handle and are indicated by the following symbols:

- Select from face fixed handle suite 609
- Select from handle suite 653 (for use with 'English Rose Contact' aluminium extrusions) or face fixed handle suite 609
- Drawer surcharge applies. Please add £45 per drawer
- Any unit with this symbol requires a 'CN' adding to the code. Please see page 80 for details

DRAWER PACK UNITS

5 Drawer Pack	4 Pan Drawer Pack	3 Pan Drawer Pack	2 Drawer Unit	2 Drawer Unit c/w Internal Drawer	Base with 1 Drawer and 2 Wicker Baskets	Sink Pan Drawer Unit 1 Dummy drawer 1 Cut out drawer option
300mm DP30 £594 (£815)	500mm PD50/4 £561 (£787)	500mm PD50/3 £475 (£666)	600mm PD60/2 £394 (£544)	600mm PDT60/2 £493	500mm WBS0 £318 (£368)	900mm PDS90/3 £588
400mm DP40 £617 (£863)	600mm PD60/4 £597 (£844)	600mm PD60/3 £519 (£727)	800mm PD80/2 £443 (£622)	800mm PDT80/2 £552		
450mm DP45 £629 (£884)	800mm PD80/4 £757 (£1,038)	800mm PD80/3 £633 (£876)	900mm PD90/2 £490 (£651)	900mm PDT90/2 £602	Oak option	2 Cut out drawer option
500mm DP50 £646 (£908)	900mm PD90/4 £786 (£1,070)	900mm PD90/3 £661 (£890)	1000mm PD100/2 £521 (£685)	1000mm PDT100/2 £639	WBS0/OAK £471 (£521)	900mm PDS90/3P2 £599
600mm DP60 £675 (£962)	1000mm PD100/4 £844 (£1,136)	1000mm PD100/3 £707 (£941)				<i>Not Contact</i>
800mm DP80 £881 (£1,199)						
900mm DP90 £911 (£1,249)						
1000mm DP100 £980 (£1,331)						

CURVED END BASE UNIT

Curved End Base Unit	Single Base Unit
300mm c/w 1 door & 1 shelf CEB301 £473	260mm Base Unit BU26 £147



Please refer to special worktop planning guidelines on page 90.

STANDARD & TALL WALL UNITS

Single Wall Unit	Double Wall Unit	Wall Bridging Unit	Double Wall Bridging Unit	Microwave Unit	Up & Over Flap Unit	Bi-Fold Wall Bridging Unit	
Standard 150/720mm WU15 £122 300/720mm WU30 £164 400/720mm WU40 £184 450/720mm WU45 £190 500/720mm WU50 £194 600/720mm WU60 £215	Tall 300/900mm TWU30 £176 400/900mm TWU40 £198 450/900mm TWU45 £204 500/900mm TWU50 £208 600/900mm TWU60 £252	Standard 600/720mm (c/w 2 doors) WU60/2 £272 800/720mm WU80 £370 900/720mm WU90 £378 1000/720mm WU100 £386	Tall 600/900mm (c/w 2 doors) TWU60/2 £289 800/900mm TWU80 £392 900/900mm TWU90 £400 1000/900mm TWU100 £411	600/288mm WBG60 £190 900/288mm WBG90 £228	600/576mm WDBG60 £349 900/576mm WDBG90 £374	600/720mm WU60/MW £325 500/720mm WU50/VR £341 600/720mm WU60/VR £361	600/720mm WBF60 £472 800/720mm WBF80 £536 900/720mm WBF90 £550

Note: 190mm height clearance required. No pelmet can be used if using handle suite 653. Do not use in corner with WC60.

CORNER WALL UNITS

L Shaped Corner Wall Unit	Standard Corner Wall Unit
Standard 630/630/720mm WCL630 £415	WC60 £286
Tall 630/630/900mm TWCL630 £509	

CURVED WALL END UNIT

260mm Wall Unit	Curved End Wall Unit	L Curved Internal Wall Unit	Curved Internal Wall Unit
260/720mm c/w 1 door & 1 adjustable shelf WU26 £158	300/300mm c/w 1 door & 1 adjustable shelf CEW301 £508	670/670mm c/w 1 door & 2 adjustable shelves WCCU67 £514	670/670mm c/w 1 door & 2 adjustable shelves WCCU67/SHK £514

Please note: WU26 is only available in Logica Glass Stone, Grey, Light Grey, Cashmere, White & Ivory, Painted Shaker & Opaco Painted

Please note: CEW301 is not available in Opaco Painted, Shaker Painted or Abbey Painted

Please refer to special planning guidelines on page 78.

STANDARD HEIGHT GLAZED WALL UNITS (720mm)

Standard Height Glazed Wall Unit			
Range Specific Frames with Clear Glass			
Standard Glass Unit & MFC Shelves	400mm	WG40* £227	500mm WG50* £267
c/w Sirius LED Lights & Glass Shelves	400mm	WG40SIR* £294	500mm WG50SIR* £338
c/w Halo LED Downlights	400mm	WG40LED* £326	500mm WG50LED* £370
c/w Edge Lit Shelves	-		500mm WG50LSH* £378
Aluminium Frame with Reflective Glass			
c/w Reflective Glass & MFC Shelves	400mm	WG40RFL £216	500mm WG50RFL £238
c/w Reflective Glass & Sirius LED Downlights	400mm	WG40RFLSIR* £273	500mm WG50RFLSIR* £297
c/w Reflective Glass & Halo LED Downlights	400mm	WG40RFLLED* £300	500mm WG50RFLLED* £324
c/w Reflective Glass & Edge Lit Shelves	-		500mm WG50RFLLSH* £331

* Not available in Opaco Painted, Grey, Light Grey, Cashmere, & Ivory. These glazed wall units are supplied with glass shelves

DRESSER HEIGHT GLAZED WALL UNITS (1207mm)

Dresser Height Glazed Unit			
Range Specific Frames with Clear Glass			
Standard Dresser Glazed Unit & MFC Shelves	500mm	DR50* £309	
c/w Sirius LED Lights & Glass Shelves	500mm	DR50SIR* £411	
c/w Halo LED Downlights	500mm	DR50LED* £439	
c/w Edge Lit Shelves	500mm	DR50LSH* £510	

* Only available in Logica Glass Stone, White & Painted Shaker. These glazed wall units are supplied with glass shelves

Please refer to page 62 for illustrations of range specific glazed doors

TALL HEIGHT GLAZED WALL UNITS (900mm)

Tall Height Glazed Unit			
Range Specific Frames with Clear Glass			
Tall Glazed Unit & MFC Shelves	500mm	TWG50* £246	
c/w Sirius LED Lights & Glass Shelves	500mm	TWG50SIR* £316	
c/w Halo LED Downlights	500mm	TWG50LED* £352	
c/w Edge Lit Shelves	500mm	TWG50LSH* £359	

* Only available in Shaker Painted

BI-FOLD GLAZED WALL UNITS (720mm)

Bi-fold Unit	
c/w Letterbox Style on bottom fascia	
600mm WBF60/LB £563	900mm WBF90/LB £652
800mm WBF80/LB £630	

Please note: These units are only available in Opaco Painted



ACCESSORY BASE/WALL UNITS

Open Unit	Wine Rack
500/720/300mm WOP50 £114	Standard 150/720/300mm WR15 £72
	Tall 150/900/300mm TWR15 £80

EURO HEIGHT UNITS

Type 1 Single Oven Housing Highline	Type 2 Single Oven Housing Drawerline	Type 3 Single Oven Housing	Type 6 Double Oven Housing	Type 8 Microwave/Steam Oven/coffee Machine Housing	Type 9 Microwave/Steam Oven/coffee Machine Housing	Type 10 Microwave/Steam Oven/coffee Machine Housing	Type 11 Microwave/Steam Oven/coffee Machine Housing	Type 1 Fridge/Freezer Housing	Type 1 Pantry Unit
600/1492mm EOH60 T1 £274	600/1492mm EOH60 T2 £367 (£425)	c/w 3 Drawers EOH60 T3 £569 (£776)	c/w 2 Drawers EOH60 T6 £413 (£546)	EOH60 T8 £379 (£436)	EOH60 T9 £685 (£950)	EOH60 T10 £398 (£455)	EOH60 T11 £704 (£969)	c/w 2 Drawers EFH60 T1 £551 (£683)	c/w 2 Drawers EP60 T1 £560 (£693)

Supplied with Stainless Steel filler

Supplied with Stainless Steel filler

(Price shown in brackets denotes full unit price with oak drawers) Please note Tall Units are available in all Group 2 ranges.

Tandem Larder Unit	Tandem Solo Unit	Convoy Premio Unit <i>(illus r/h)</i>	Larder Unit	Double Larder Unit	Larder Unit c/w Pull Out Wirework	Type 1 Pullout Larder Unit	Type 2 Pullout Larder Unit
500/2117mm LU50TDM £1,283	600/2117mm LU60SOLO £1,090	600/2117mm (L/H) LU60CONVL £1,453	300/2117mm LU30 £446 400/2117mm LU40 £484 500/2117mm LU50 £521	1000/2117mm LU100 £1,067	With Arena Shelves Standard 300/2117mm LU30A £1,083 400/2117mm LU40A £1,216 500/2117mm LU50A £1,348	With Graphite Wirework Standard 300/2117mm LU30B £1,197 400/2117mm LU40B £1,344 500/2117mm LU50B £1,490	c/w 3 Pan Drawers, 4 Internal Drawers Standard 300/2117mm LU30P T1 £955 400/2117mm LU40P T1 £1,019 500/2117mm LU50P T1 £1,083
Tall 500/2297mm TLU50TDM £1,309	with Graphite Wirework 600/2117mm LU60SOLO £1,204	600/2117mm (R/H) LU60CONVR £1,453	600/2117mm LU60 £555	Tall 1000/2297mm TLU100 £1,100	Tall 300/2297mm TLU30A £1,128 400/2297mm TLU40A £1,266 500/2297mm TLU50A £1,404	Tall 300/2117mm TLU30B £1,246 400/2117mm TLU40B £1,399 500/2117mm TLU50B £1,551	c/w 2 Pan Drawers, 3 Internal Drawers Standard 300/2117mm LU30P T2 £806 400/2117mm LU40P T2 £862 500/2117mm LU50P T2 £918
with Graphite Wirework 500/2117mm LU50BTDM £1,418	with Graphite Wirework 500/2117mm LU50BTDM £1,446	600/2117mm (L/H) LU60CONVL £1,605	Tall 300/2297mm TLU30 £467 400/2297mm TLU40 £506 500/2297mm TLU50 £543	Tall 300/2297mm TLU30A £1,128 400/2297mm TLU40A £1,266 500/2297mm TLU50A £1,404	Tall 300/2117mm TLU30B £1,246 400/2117mm TLU40B £1,399 500/2117mm TLU50B £1,551	Tall 300/2297mm TLU30P T1 £975 400/2297mm TLU40P T1 £1,040 500/2297mm TLU50P T1 £1,104	Tall 300/2297mm TLU30P T2 £826 400/2297mm TLU40P T2 £883 500/2297mm TLU50P T2 £939
		600/2117mm (R/H) LU60CONVR £1,605	(Please specify handing of door)				

Type 3 Larder Unit	Type 4 Larder Unit	Type 1 1000 Corner Larder to Larder	Type 2 1000 Corner Larder to Larder with Le-Mans Pull Out Storage	Type 3 1000 Corner Larder to Base
c/w 6 Internal Drawers Standard 300/2117mm LU30P T3 £1,001 (£1,231) Tall 300/2297mm TLU30P T3 £1,021 (£1,251)	c/w 4 Internal Drawers Standard 300/2117mm LU30P T4 £806 (£959) Tall 300/2297mm TLU30P T4 £826 (£979)	400/2117mm LUC104T1 £616 500/2117mm (R/H) LUC105T1 £666 600/2117mm LUC106T1 £678 Tall 400/2297mm TLUC104T1 £650 500/2117mm TLUC105T1 £674	500/2117mm (L/H) LUC105T2L £1,884 500/2117mm (R/H) LUC105T2R £1,884 600/2117mm (L/H) LUC106T2L £1,972 600/2117mm (R/H) LUC106T2R £1,972 Tall 500/2297mm (L/H) TLUC105T2L £1,913 500/2297mm (R/H) TLUC105T2R £1,913 <i>(Please specify handing of Le Mans)</i>	with Graphite Wirework 400/2117mm LUC104 T3 £843 500/2117mm (R/H) LUC105 T3 £875 600/2117mm (L/H) LUC106 T3 £901 Tall 400/2297mm TLUC104 T3 £876 500/2297mm TLUC105 T3 £903
500/2117mm LU50P T3 £1,130 (£1,416) 600/2117mm LU60P T3 £1,179 (£1,494)	500/2117mm LU50P T4 £916 (£1,106) 500/2297mm LU50P T4 £937 (£1,128)	500/2117mm LUC104T1 £650 500/2117mm TLUC105T1 £674	500/2117mm (L/H) LUC105T2L £1,884 500/2117mm (R/H) LUC105T2R £1,884 600/2117mm (L/H) LUC106T2L £1,972 600/2117mm (R/H) LUC106T2R £1,972 Tall 500/2297mm (L/H) TLUC105T2L £1,913 500/2297mm (R/H) TLUC105T2R £1,913 <i>(Please specify handing of Le Mans)</i>	500/2117mm (L/H) LUC104 T3 £843 500/2117mm (R/H) LUC105 T3 £875 600/2117mm (L/H) LUC106 T3 £901 Tall 400/2297mm TLUC104 T3 £876 500/2297mm TLUC105 T3 £903
		600/2117mm LU60P T4 £1,003 (£1,213)	500/2117mm TLUC105T1 £674	500/2117mm LUC104 T3 £843 500/2117mm (R/H) LUC105 T3 £875 600/2117mm (L/H) LUC106 T3 £901 Tall 400/2297mm TLUC104 T3 £876 500/2297mm TLUC105 T3 £903
			<i>(Please specify handing of Le Mans)</i>	

* Larder to larder units do not include a blanking panel

Type 4 1000 Corner Larder to Base with Le-Mans Pull Out Storage	Type 5 1000 Corner Larder to Base with planked end panel	Type 6 1000 Corner Larder to Base with planked end panel & Le-Mans Pull Out Storage	1000 Butlers Larder with Wine Racks
with Graphite Wirework 500/2117mm (L/H) LUC105 T4L £2,102 500/2117mm (R/H) LUC105 T4R £2,102 600/2117mm (L/H) LUC106 T4L £2,190 600/2117mm (R/H) LUC106 T4R £2,190 Tall 500/2297mm (L/H) TLUC105 T4L £2,131 500/2297mm (R/H) TLUC105 T4R £2,131	with Graphite Wirework 400/2117mm LUC104 T5 £914 500/2117mm (R/H) LUC105 T5 £949 600/2117mm (L/H) LUC106 T5 £978 Tall 400/2297mm TLUC104 T5 £951 500/2297mm TLUC105 T5 £980	with Graphite Wirework 500/2117mm (L/H) LUC105 T6L £2,281 500/2117mm (R/H) LUC105 T6R £2,281 600/2117mm (L/H) LUC106 T6L £2,376 600/2117mm (R/H) LUC106 T6R £2,376 Tall 500/2297mm (L/H) TLUC105 T6L £2,312 500/2297mm (R/H) TLUC105 T6R £2,312	1000/2117mm LU100BUT £1,162 1000/2297mm TLU100BUT £1,214 <i>Please note: This unit is only available on Lissa Oak cabinet</i>
500/2117mm (L/H) LUC105 T4L £2,102 500/2117mm (R/H) LUC105 T4R £2,102 600/2117mm (L/H) LUC106 T4L £2,190 600/2117mm (R/H) LUC106 T4R £2,190 Tall 500/2297mm (L/H) TLUC105 T4L £2,131 500/2297mm (R/H) TLUC105 T4R £2,131	400/2117mm LUC104 T5 £914 500/2117mm (R/H) LUC105 T5 £949 600/2117mm (L/H) LUC106 T5 £978 Tall 400/2297mm TLUC104 T5 £951 500/2297mm TLUC105 T5 £980	500/2117mm (L/H) LUC105 T6L £2,281 500/2117mm (R/H) LUC105 T6R £2,281 600/2117mm (L/H) LUC106 T6L £2,376 600/2117mm (R/H) LUC106 T6R £2,376 Tall 500/2297mm (L/H) TLUC105 T6L £2,312 500/2297mm (R/H) TLUC105 T6R £2,312	1000/2117mm LU100BUT £1,162 1000/2297mm TLU100BUT £1,214 <i>Please note: This unit is only available on Lissa Oak cabinet</i>

BUTLERS LARDER ACCESSORY ITEMS



Two 200 x 200mm Oak Boxes
BOX200K **£56**

Oak Framed Wicker Basket with runners (To suit 500 wide unit)
WKBASKOK **£145**

Two Small Wicker Baskets (225x250x150mm)
WKBASML **£79**

Oak Door Rack
OAKSPICE335 **£318**

ENGLISH ROSE CONTACT – HANDLE-LESS KITCHENS: Certain units will require a handle and are indicated by the following symbols:
 ♦ Select from face fixed handle suite 609
 ♦ Select from handle suite 653 (for use with 'English Rose Contact' aluminium extrusions) or face fixed handle suite 609
 ★ Drawer surcharge applies. Please add £45 per drawer
 ▲ Any unit with this symbol requires a 'CN' adding to the code. Please see page 80 for details

Built Under Oven Housing	Built Under Oven Housing with drawer	Type 1 Double Oven Housing	Type 2 Double Oven Housing	Type 3 Double Oven Housing	Type 5 Single Oven/Microwave Unit	Type 6 Single Oven Housing	Type 7 Single Oven Housing	Type 8 Single Oven Housing	Type 9 Microwave/Steam Oven/coffee Machine Housing	Type 10 Microwave/Steam Oven/coffee Machine Housing
600mm BUOH £113	600mm BUOHD £194	600/2117mm OH60 T1 £447 Tall 600/2297mm TOH60 T1 £465	c/w 2 Drawers 600/2117mm OH60 T2 £629 (£778) Tall 600/2297mm TOH60 T2 £645 (£795)	c/w 3 Drawers 600/2117mm OH60 T3 £707 (£896) Tall 600/2297mm TOH60 T3 £723 (£913)	600/2117mm OH60 T5 £434 Tall 600/2297mm TOH60 T5 £465	600/2117mm OH60 T6 £555 (£612) Tall 600/2297mm TOH60 T6 £572 (£629)	600/2117mm OH60 T7 £661 (£775) Tall 600/2297mm TOH60 T7 £677 (£792)	600/2117mm OH60 T8 £862 (£1,126) Tall 600/2297mm TOH60 T8 £879 (£1,143)	600/2117mm OH60 T9 £672 (£786) Tall 600/2297mm TOH60 T9 £689 (£803)	600/2117mm OH60 T10 £627 (£777) Tall 600/2297mm TOH60 T10† £691 (£841)

† Supplied with Stainless Steel filler

Type 11 Microwave/Steam Oven/coffee Machine Housing	Type 12 Microwave/Steam Oven/coffee Machine Housing	Type 13 Microwave/Steam Oven/coffee Machine Housing	Type 1 Fridge/Freezer Housing	Type 2 Fridge/Freezer Housing	Type 5 Fridge & Freezer Housing	Type 6 Combi Fridge/Freezer Housing	Type 8 Combi Fridge/Freezer Housing
600/2117mm OH60 T11† £646 (£796) Tall 600/2297mm TOH60 T11 £690 (£840)	OH60 T12 £446 Tall 600/2297mm TOH60 T12† £513	OH60 T13† £465 Tall 600/2297mm TOH60 T13 £512	600/2117mm FFH60 T1 £591 Tall 600/2297mm TFFH60 T1 £609	c/w 2 Drawers 600/2117mm FFH60 T2 £766 (£916) Tall 600/2297mm TFFH60 T2 £783 (£932)	600/2117mm FFH60 T5 £529 Tall 600/2297mm TFFH60 T5 £572	600/2117mm FFH60 T6 £527	Tall* 600/2297mm TFFH60 T8 £576

† Supplied with Stainless Steel filler

* Please refer to fascia matrix on page 57 & page 87 for layout of doors.

Semi Integrated Dishwasher Fascia	Highline Integrated Fridge/Freezer Fascia	Drawerline Integrated Fridge/Freezer Fascia	Integrated Hood Fascia	Highline Dishwasher Fascia	Drawerline Dishwasher Fascia
600/572mm IFS60 £96	600mm IF60FR £116	600mm IFD60FR £149	600/450mm IF60EXT £93	450mm Slimline IF45 £100 600mm Fully Integrated IF60DW £116	450mm Slimline IFD45 £127 600mm Fully Integrated IFD60DW £149

Cornices & Pelnets	Traditional Cornice PVC Wrapped (H - 70mm) 1750mm 3600mm	Traditional Cornice Painted/Foil (H - 70mm) 1750mm 3600mm	Traditional Cornice Painted (H - 56mm) 1750mm 3600mm	Square section Cornice/Pelmet/Pilaster (H - 36mm) 1750mm 3600mm
Shaker Painted - all colours*		TCPAI_H £47 TCPAI_ £84		CBPAI_H £66 CBPAI_ £102
Logica Gloss Ivory				CBPVCIVH £66 CBPVCIV £102
Logica Gloss White	TCPVCGWH £71 TCPVCGW £112			CBPVCGWH £66 CBPVCGW £102
Logica Gloss Stone	TCPVCSTH £71 TCPVCST £112			CBPVCSTH £66 CBPVCST £102
Logica Gloss Grey				CBPVCGGH £66 CBPVCGG £102
Logica Gloss Light Grey				CBPVCLYH £66 CBPVCCLY £102
Logica Gloss Cashmere				CBPVCSSH £66 CBPVCSS £102
Opaco Painted - all colours*		TCPAT_H £47 TCPAT_ £84		CBMAT_H £66 CBMAT_ £102
Abbey (available Sept 2018)		TCPVCLMTH £47 TCPVCLMT £84		CBPVCVYH £66 CBPVCVY £102

Cornices & Pelnets cont'd	Curved Cornice Painted (H - 56mm) External	Curved Cornice/Pelmet (H - 36mm) External	Traditional Internal Curved Section (H-56mm)	Internal Curved Section (H-36mm) Square	2.4m Curved Corner Section 100mm Wide	938mm Curved Corner Section 50mm Wide	1387mm Curved Corner Section 50mm Wide	Traditional Curved Cornice Corner Block	Traditional Corner Block 90°
Shaker Painted - all colours*		BCBV £127							
Logica Gloss Ivory		BCVGI £127		BCBIGI £126					
Logica Gloss White		BCVGIW £127		BCBIGW £126	CCSGW £194				
Logica Gloss Stone		BCVST £127		BCBIST £126	CCSST £194				
Logica Gloss Grey		BCVGG £127		BCBIGG £126					
Logica Light Grey		BCVLY £127		BCBILY £126					
Logica Cashmere		BCVCS £127		BCBICS £126					
Opaco Painted - all colours*	TCCV_ £187	CCBV_ £127	TCCI_ £141	CCBI_ £126	CCSBW_ £55	CCSDT_ £77	CCSTC_ £77	TCCB_ £49	
Abbey (available Sept 2018)									

Decorative Accessories	Base Corner Pilaster (Painted) (h920 w100mm)	Canopy † (Plain finish) 640 x 1105mm - can be cut down to 460 x 850mm	Pilaster (BM & WH is painted) (w75mm)	Square Pilaster (h920 w100mm)
Shaker Painted - all colours*				
Logica Gloss Ivory				
Logica Gloss White				
Logica Gloss Stone				
Logica Gloss Grey				
Logica Light Grey				
Logica Cashmere				
Opaco Painted - all colours*	BCF_ £307	CANOPYMAT_ £550	PILBMAT_ £174	PILSQMAT_ £307
Abbey (available Sept 2018)				

† Can take extractor flange size 380 x 730mm

* = Use colour code suffix to specify the colour of your accessory

- | | |
|--------------------------|-------------------------|
| Opaco Painted = | Shaker Painted = |
| (DB) Painted Light Blue | (FB) Light Blue Foil |
| (DO) Painted Oyster | (FO) Oyster Foil |
| (DR) Painted Green | (FR) Green Foil |
| (DT) Painted White | (FT) White Foil |
| (DV) Painted Ivory | (FV) Ivory Foil |
| (DY) Painted Sage Grey | (FY) Sage Grey Foil |
| (DL) Painted Light Grey | (FL) Light Grey Foil |
| (DU) Painted Cashmere | (FE) Cashmere Foil |
| (DH) Painted Hickory | (FH) Hickory Foil |
| (DS) Painted Steel Blue | (FS) Steel Blue Foil |
| (DX) Painted Oxford Blue | (FX) Oxford Blue Foil |
| (DM) Painted Limestone | (FM) Limestone Foil |
| (DK) Painted Anthracite | (FK) Anthracite Foil |
| (DJ) Painted Sandstone | (FJ) Sandstone Foil |

Plinths	2650mm Plinth (18mm MFC) Supplied with sealing strip	Graphite Plinth with Seal 150 x 2750	2650mm Plinth (16mm MFC) Aluminium effect	2550mm Plinth Gloss PVC	3000mm Plinth Painted	2650mm Mirrored Plinth	Curved External Mirrored Plinth	Curved Internal Mirrored Plinth	Curved Plinth Painted (External)	Curved Plinth PVC (External)	Plinth Internal Curved Section	100mm Filler Panels 18mm MFC - 2297mm Edged 1 Long & 2 Short	Filler Panel Painted - 2350 x120mm (18mm Thick)	100mm Filler Panels 18mm Aluminium - 2297mm Edged 1 Long & 2 Short	100mm Graphite Wide Cornice/ Pelmet/ Filler 2400 x 100 MFC
Shaker Painted - all colours*					PLPAI_ £56	PLMIR £84	PLCMVIR £183		PLCV_ £118			TFPFC1_ £43	TF1AL £30	TF1GR £30	
Logica Gloss Ivory	PL1GI £34	PLGR £34	PLAL £34	PLPVCGI £107	PLMIR £84	PLCMVIR £183	PLCV93MIR £175		PLCVGI £105	PLCV93GI £130	TF1GI £30		TF1AL £30	TF1GR £30	
Logica Gloss White	PL1GW £34	PLGR £34	PLAL £34	PLPVCW1 £107	PLMIR £84	PLCMVIR £183	PLCV93MIR £175		PLCVST1 £105	PLCV93ST £130	TF1GW £30		TF1AL £30	TF1GR £30	
Logica Gloss Stone	PL1ST £34	PLGR £34	PLAL £34	PLPVCST £107	PLMIR £84	PLCMVIR £183	PLCV93MIR £175		PLCVGG £105	PLCV93GG £130	TF1ST £30		TF1AL £30	TF1GR £30	
Logica Gloss Grey		PLGR £34	PLAL £34	PLPVCGG £107	PLMIR £84	PLCMVIR £183	PLCV93MIR £175		PLCVLY £105	PLCV93LY £130			TF1AL £30	TF1GR £30	
Logica Gloss Light Grey		PLGR £34	PLAL £34	PLPVCCLY £107	PLMIR £84	PLCMVIR £183	PLCV93MIR £175		PLCVCS £105	PLCV93CS £130	TF1GC £30		TF1AL £30	TF1GR £30	
Logica Gloss Cashmere	PL1GC £34	PLGR £34	PLAL £34	PLPVCSS £107	PLMIR £84	PLCMVIR £183	PLCV93MIR £175		PLCVCS £105	PLCV93CS £130		TFMAT_ £72	TF1AL £30	TF1GR £30	
Opaco Painted - all colours*					PLMAT_ £84	PLMIR £84	PLCMVIR £183	PLCV93MIR1 £193	PLCV_ £118					TF1AL £30	TF1GR £30
Abbey (available Sept 2018)	PLMTS £34	PLGR £34	PLAL £34			PLMIR £84						TFMTS_ £30		TF1AL £30	TF1GR £30

(▲ = Curved Plinth sections for use with Painted/PVC Plinths only) (◆ 2400 x 120mm 22mm Thick)

Panels	End Support Panel 920 x 670 MFC	End Support Panel 920 x 670 Aluminium	End Support Panel 890 x 670 Painted	End Support Panel 920 x 670 PVC Gloss	Island End Panel 716 860 PVC Gloss	Plain Add On Base End Panel 890 x 670 Painted Wood Grain	Add On Wall End Panel 760 x 375 MFC	Add On Wall End Panel 1584 x 375 MFC/ Painted	Plain Add On Wall End Panel 1584 x 375 Painted Wood Grain	Add On Euro Housing End Panel 1562 x 670	Plain Add On Housing End Panel 2400 x 670 Painted	Plain Add On Housing End Panel 2347 x 670 Painted Wood Grain	Graphite End Support Panel/Add on Base End Panel 940 x 670 MFC	Graphite Multi Purpose Panel/Larder Add On End Panel 2400 x 670 MFC	Multi Purpose Panel 2347 x 670 MFC	Multi Purpose Panel 2347 x 670 Aluminium
Shaker Painted - all colours*						ESPPAIB1 £111				EPPAIW1 £111		EPPAIH1 £211	ESP1GR £34	MPP1GR £111	MPP1AL £111	
Logica Gloss Ivory	ESP1GI £34	ESP1AL £34	ESPPVCGI £118	IEPPVCGI £65									ESP1GR £34	MPP1GR £111	MPP1GI £111	MPP1AL £111
Logica Gloss White	ESP1GIW £34	ESP1AL £34	ESPPVCGW1 £118	IEPPVCGW £65									ESP1GR £34	MPP1GR £111	MPP1GW £111	MPP1AL £111
Logica Gloss Stone	ESP1ST £34	ESP1AL £34	ESPPVCGST1 £118	IEPPVCGST £65									ESP1GR £34	MPP1GR £111	MPP1ST £111	MPP1AL £111
Logica Gloss Grey		ESP1AL £34	ESPPVCGG £118	IEPPVCGG £65									ESP1GR £34	MPP1GR £111		MPP1AL £111
Logica Gloss Light Grey		ESP1AL £34	ESPPVCLY £118	IEPPVCLY £65									ESP1GR £34	MPP1GR £111		MPP1AL £111
Logica Gloss Cashmere	ESP1GC £34	ESP1AL £34	ESPPVCCS £118	IEPPVCCS £65									ESP1GR £34	MPP1GR £111		MPP1AL £111
Opaco Painted - all colours*		ESP1AL £34	ESPMATB £111				EPMATW £111				EPMATH £211		ESP1GR £34	MPP1GR £111		MPP1AL £111
Abbey (available Sept 2018)	ESPMTS £34	ESP1AL £34		IEPHORMTS £65		EPWMMTS £111	EPWDMTS £111				EPEMTS £111		ESP1GR £34	MPP1GR £111	MPPMTS £111	MPP1AL £111

Panels cont'd	Multi Purpose Panel 2347 x 670 PVC Gloss	Breakfast Bar Back Panel 940 x 2010 Aluminium (Edged 1L, 1S)	Breakfast Bar Back Panel 890 x 2050 Painted	Breakfast Bar Back Panel 940 x 2010 Gloss MFC/MFC	Breakfast Bar Back Panel 890 x 2050 PVC Gloss	Breakfast Bar Back Panel 890 x 2050 Painted Wood Grain 2 Pieces	Graphite Breakfast Bar Back Panel 940 x 2010 MFC	Edging Tape 10m PVC Unglued	10 Metre Roll of Graphite Edging Tape	Edging Tape 5m PVC Unglued (1.3mm thick)	10 Metre Aluminium Edging Tape - Unglued PVC	5 Metre Roll Graphite Edging Tape (1.3mm thick)	5 Metre Aluminium Edging Tape - Unglued PVC (1.3mm thick)
Shaker Painted - all colours*		BBBP1AL £87					BBBPAI1 £211	BBBP1GR £87	ETGR £17		ETAL £17	ETSGR £26	ET5AL £26
Logica Gloss Ivory	MPPPVCGI £256	BBBP1AL £87		BBBP1GI £116	BBBPPVCGI £316			BBBP1GR £87	ETGI £17	ET5GI £26	ETAL £17	ETS5GR £26	ET5AL £26
Logica Gloss White	MPPPVCW1 £256	BBBP1AL £87		BBBP1GW £116	BBBPPVCW1 £316			BBBP1GR £87	ETGW £17	ET5GW £26	ETAL £17	ETS5GR £26	ET5AL £26
Logica Gloss Stone	MPPPVCST1 £256	BBBP1AL £87		BBBP1ST £116	BBBPPVCST1 £316			BBBP1GR £87	ETST £17	ET5ST £26	ETAL £17	ETS5GR £26	ET5AL £26
Logica Gloss Grey	MPPPVCGG £256	BBBP1AL £87			BBBPPVCGG £316			BBBP1GR £87	ETGR £17	ET5GR £26	ETAL £17	ETS5GR £26	ET5AL £26
Logica Light Grey	MPPPVCCLY £256	BBBP1AL £87			BBBPPVCLY £316			BBBP1GR £87	ETGR £17	ET5GR £26	ETAL £17	ETS5GR £26	ET5AL £26
Logica Gloss Cashmere	MPPPVCSS £256	BBBP1AL £87		BBBP1GC £116	BBBPPVCCS £316			BBBP1GR £87	ETGC £17	ET5GC £26	ETAL £17	ETS5GR £26	ET5AL £26
Opaco Painted - all colours*		BBBP1AL £87	BBBPMAT £211					BBBP1GR £87	ETGR £17	ET5GR £26	ETAL £17	ETS5GR £26	ET5AL £26
Abbey (available Sept 2018)		BBBP1AL £87		BBBPMTS £116				BBBP1GR £87	ETGR £17	ET5MTS £26	ETAL £17	ETS5GR £26	ET5AL £26

(Price shown in brackets denotes full unit price with oak drawers. Oak drawers not available in Fusion or Concept Painted.) Please note Tall Units are available in all Group 3 ranges.

Single Base Unit	Double Base Unit	Belfast Sink Base Unit	Breakfront Unit with Shelf	Breakfront Unit with Pull Out Wirework (R/H illus)	Base Unit with 2 Pull Out Arena Shelves	Base Unit with Pull Out Chrome Wine Rack	Base with 2 Pull Out Wirework	Base Unit with 2 Pull Out Wirework and Stainless Steel Fascia	Base c/w 2 (140mm deep) Veg Baskets	Type 2 Pullout	Type 3 Pullout c/w 2 Internal Drawers
150mm BU15H *£100	800mm BU80 £371	600mm BEL60 £193	300mm BFR530 £220	300mm c/w Arena Shelves L/H BFR30LA £463	300mm B30AW £405	400mm B40WRL £554	150mm BU15 £283	150mm BU15SS £344	400mm B40V £308	300mm B30PT2 £307	300mm B30PT3 £365 (£442)
300mm BU30 £184	900mm BU90 £377			300mm c/w Arena Shelves R/H BFR30RA £463	with Graphite Wirework 300mm B30BW £448	400mm B40WRR £554	with Graphite Wirework 150mm BU15B £313	with Graphite Wirework 150mm BU15BSS £380	500mm B50V £327	400mm B40PT2 £332	400mm B40PT3 £393 (£480)
400mm BU40 £205	1000mm BU100 £377								600mm B60V £361	450mm B45PT2 £338	450mm B45PT3 £402 (£493)
450mm BU45 £209										500mm B50PT2 £342	500mm B50PT3 £407 (£503)
500mm BU50 £209										600mm B60PT2 £378	600mm B60PT3 £445 (£550)
600mm BU60 £239											

Base Unit with Le-Mans Pull Out Storage* (L/H illus)	Corner Base Unit* (L/H illus)	L Shaped Corner Base Unit	Corner Carousel Base Unit* (L/H illus)	Corner Base Unit c/w Vario Pull Out Storage* (R/H illus)	L Shaped Corner Base Unit c/w 2 doors	Curved L Shaped Corner Base Unit c/w 2 doors	Curved L Shaped Corner Base Unit
900mm L/H c/w 450mm door BCCB145ML £921	with Graphite Wirework 900mm L/H c/w 450mm door BCCB145ML £1,018	800mm c/w 400mm door BC80 £317	1000mm c/w 500mm door & Arena Shelves BCC100A £785	900mm L/H c/w Arena Shelves 450mm door BCM145LA £1,039	930/930mm c/w Arena Shelves BCC93A £934	930/930mm BCCU93/2 £794	930/930mm BCCU93/SHK £555
1000mm L/H c/w 500mm door BCC100ML £953	1000mm L/H c/w 500mm door BCC100ML £1,053	900mm c/w 450mm door BC90 £323	1000mm c/w 600mm door & Arena Shelves BCC120A £806	1000mm L/H c/w Arena Shelves 500mm door BCM100LA £1,050	930/930mm c/w Graphite Wirework BCC93B £1,032	Please note: <i>BCCU93/2 is only available in Fusion Gloss & Fusion Painted</i>	Please note: <i>This unit is only available in Classic Painted</i>
1000mm L/H c/w 600mm door BCC160ML £1,003	1000mm L/H c/w 600mm door BCCB160ML £1,109	1000mm c/w 500mm door BC100 £323	1000mm c/w 600mm door & Arena Shelves BCC120A £806	1000mm R/H c/w Arena Shelves 600mm door BCM160LA £1,065	930/930mm c/w Graphite Wirework BCC93B £1,032	Please note: <i>BCCU93/2 is only available in Fusion Gloss & Fusion Painted</i>	Please note: <i>This unit is only available in Classic Painted</i>
900mm R/H c/w 450mm door BCC145MR £921	900mm R/H c/w 450mm door BCCB145MR £1,018	1000mm c/w 500mm door BC100 £323	1000mm c/w 600mm door & Arena Shelves BCC120A £806	900mm R/H c/w Arena Shelves 450mm door BCM145RA £1,039	930/930mm c/w Graphite Wirework BCC93B £1,032	Only on Gloss Stone, Matt Ivory, Gloss White, Platinum White or Gloss Ivory cabinets	Only on Matt Ivory, Lissa Oak, Sand Oak, Aluminium or Platinum White cabinets
1000mm R/H c/w 500mm door BCC100MR £953	1000mm R/H c/w 500mm door BCCB100MR £1,053	1000mm c/w 600mm door BC100 £323		1000mm R/H c/w Arena Shelves 500mm door BCM100RA £1,050			
1000mm R/H c/w 600mm door BCC160MR £1,003	1000mm R/H c/w 600mm door BCCB160MR £1,109	1000mm c/w 600mm door BC100 £323		1000mm R/H c/w Arena Shelves 600mm door BCM160RA £1,065			

* Corner base units do not include a blanking panel. The end support panel ESP can be used for this purpose if required.

Single Base Unit	Double Base Unit	Base Unit 1 Dummy Drawer	Base Unit Dummy Drawer	Base Unit 2 Dummy Drawers	Breakfront Unit with Shelf	Breakfront Unit with Pull Out Wirework (R/H illus)	Base Unit with 2 Pull Out Arena Shelves	Base Unit with Pull Out Arena Shelf	Base c/w 2 (140mm deep) Veg Baskets	Type 1 Pullout c/w 1 Pan Drawer, 1 Internal Drawer
300mm BD30 £270 (£314)	800mm BD80 £551 (£649)	800mm BSD80 £484 (£534)	300mm BDD30 £215	800mm BDD80 £438	300mm BFR530D £254	300mm c/w Arena Shelves L/H BFR30DLA £483	300mm BDD30AW £395	400mm BDD40WRL £530	400mm BD40V £370 (£416)	300mm BD30PT1 £413
400mm BD40 £294 (£343)	900mm BD90 £560 (£662)	900mm BSD90 £492 (£542)	400mm BDD40 £238	900mm BDD90 £443		300mm c/w Arena Shelves R/H BFR30DRA £483	with Graphite Wirework BDD40WRR £530	500mm BD50V £392 (£441)	500mm BD50V £392 (£441)	400mm BD40PT1 £443
450mm BD45 £299 (£350)	1000mm BD100 £567 (£671)	1000mm BSD100 £496 (£549)	450mm BDD45 £242	1000mm BDD100 £446			300mm BDD30BW £436	600mm BD60V £426 (£480)	600mm BD60V £426 (£480)	450mm BD45PT1 £453
500mm BD50 £302 (£355)			500mm BDD50 £243							500mm BD50PT1 £461
600mm BD60 £335 (£392)			600mm BDD60 £275							600mm BD60PT1 £501

Corner Base Unit* (L/H illus)	L Shaped Corner Base Unit	Corner Carousel Base Unit* (L/H illus)	Corner Base Unit c/w Vario Pull Out Storage* (R/H illus)	L Shaped Corner Carousel Base Unit	Base Unit with Le-Mans Pull Out Storage* (L/H illus)
800mm c/w 400mm door BCD80 £401 (£451)	930/930mm BCD93 £605	1000mm c/w 500mm door & Arena Shelves BCCD10A £785 (£834)	900mm L/H c/w 450mm door & Arena Shelves BCMD14LA £1,111 (£1,159)	930/930mm c/w Arena Shelves BCCD93A £873	900mm L/H c/w 450mm door BCCD14ML £924 (£972)
900mm c/w 450mm door BCD90 £409 (£459)	1030/1030mm BCD103 £618	1000mm c/w 600mm door & Arena Shelves BCCD12A £806 (£860)	1000mm L/H c/w 500mm door & Arena Shelves BCMD10LA £1,124 (£1,173)		900mm R/H c/w 450mm door BCCD14MR £924 (£972)
1000mm c/w 500mm door BCD100 £412 (£464)			900mm R/H c/w 450mm door & Arena Shelves BCMD14RA £1,111 (£1,124)		1000mm L/H c/w 600mm door BCCD10ML £956 (£1,006)
1000mm c/w 600mm door BCD120 £439 (£496)			1000mm R/H c/w 500mm door & Arena Shelves BCMD10RA £1,124 (£1,173)		1000mm R/H c/w 600mm door BCCD10MR £956 (£1,006)
			1000mm L/H c/w 600mm door & Arena Shelves BCMD16LA £1,140 (£1,194)		1000mm R/H c/w 500mm door BCCD16ML £1,004 (£1,058)
			1000mm R/H c/w 600mm door & Arena Shelves BCMD16RA £1,140 (£1,194)		1000mm R/H c/w 500mm door BCCD16MR £1,004 (£1,058)
					1000mm R/H c/w 600mm door BCCD16MR £1,004 (£1,058)

* Corner base units do not include a blanking panel. The end support panel ESP can be used for this purpose if required.

5 Drawer Pack	4 Pan Drawer Pack	3 Pan Drawer Pack	2 Drawer Unit	2 Drawer Unit c/w Internal Drawer	Base with 1 Drawer and 2 Wicker Baskets	Sink Pan Drawer Unit 1 Dummy drawer 1 Cut out drawer option
300mm DP30 £598 (£820)	500mm PD50/4 £572 (£798)	500mm PD50/3 £489 (£680)	600mm PD60/2 £399 (£549)	600mm PDT60/2 £495	500mm WB50 £314 (£363)	900mm PDS90/3 £643
400mm DP40 £625 (£871)	600mm PD60/4 £604 (£850)	600mm PD60/3 £521 (£728)	800mm PD80/2 £463 (£642)	800mm PDT80/2 £569		2 Cut out drawer option
450mm DP45 £638 (£892)	800mm PD80/4 £776 (£1,056)	800mm PD80/3 £628 (£871)	900mm PD90/2 £508 (£670)	900mm PDT90/2 £617		900mm PDS90/3P2 £654
500mm DP50 £654 (£916)	900mm PD90/4 £834 (£1,118)	900mm PD90/3 £714 (£943)	1000mm PD100/2 £544 (£707)	1000mm PDT100/2 £658	Oak option £463 (£512)	
600mm DP60 £686 (£972)	1000mm PD100/4 £885 (£1,177)	1000mm PD100/3 £758 (£991)				
800mm DP80 £923 (£1,242)						
900mm DP90 £954 (£1,292)						
1000mm DP100 £1,012 (£1,362)						

Curved End Base Unit	Single Base Unit
300mm c/w 1 door & 1 shelf CEB301 £485	260mm Base Unit BU26 £151
Please note: <i>This unit is not available in Concept Painted.</i>	Please note: <i>This unit is not available in Concept Painted.</i>



Single Wall Unit	Double Wall Unit	Dresser Unit with Solid Door	Wall Bridging Unit	Double Wall Bridging Unit	Microwave Unit	Up & Over Flap Unit	Bi-Fold Wall Bridging Unit
Standard 150/720mm WU15 £141	Standard 600/720mm WU60/2 £288	500/1207mm DR50/SL £234	600/288mm WBG60 £191	600/576mm WDBG60 £353	600/720mm WU60/MW £323	500/720mm WU50/VR £345	600/720mm WBF60 £476
Tall 300/720mm WU30 £171	Tall 600/900mm TWU60/2 £305	800/900mm TWU80 £387	900/288mm WBG90 £254	900/576mm WDBG90 £429	800/720mm WU60/VR £374	800/720mm WBF80 £555	900/720mm WBF90 £569
400/720mm WU40 £192	800/720mm WU80 £387	Please note: <i>This unit is available in Classic Painted only</i>					
450/720mm WU45 £198	400/900mm TWU40 £207					Note: <i>190mm height clearance required. Do not use in corner with WCG0.</i>	Note: <i>This unit is only available in Classic Painted, Shaker Gloss Stone, Concept Painted, Fusion Painted & Fusion Gloss</i>
500/720mm WU50 £202	450/900mm TWU45 £213						Note: <i>190mm height clearance required.</i>
600/720mm WU60 £232	500/900mm TWU50 £216						
	600/900mm TWU60 £272						

L Shaped Corner Wall Unit	Standard Corner Wall Unit
Standard 630/630/720mm WCL630 £458	WC60 £290
Tall 630/630/900mm TWCL630 £519	

260mm Wall Unit	Curved End Wall Unit	L Curved Internal Wall Unit c/w 2 doors	L Curved Internal Wall Unit
260/720mm c/w 1 door & 1 adjustable shelf WU26 £156	300/300mm c/w 1 door & 1 adjustable shelf CEW301 £500	670/670mm c/w 2 doors & 2 adjustable shelves WCCU67/2 £756	670/670mm c/w 1 door & 2 adjustable shelves WCCU67/SHK £508
Please note: <i>This unit not available in Concept Painted.</i>	Please note: <i>This unit not available in Gloss White Shaker & Concept Painted</i>	Please note: <i>This unit is only available in Fusion Gloss & Fusion Painted</i>	Please note: <i>This unit is only available in Classic Painted</i>
	300/300mm c/w 1 door & 1 adjustable shelf TCEW301 £600	Only on Gloss Stone, Matt Ivory, Gloss White, Platinum White or Gloss Ivory cabinets	Only on Matt Ivory, Lissa Oak, Sand Oak or Platinum White cabinets
	Please note: <i>Only available in Classic Painted</i>		

(Price shown in brackets denotes full unit price with oak drawers. Oak drawers not available in Fusion or Concept Painted.) Please note Tall Units are available in all Group 3 ranges.

STANDARD HEIGHT GLAZED WALL UNITS (720mm)

Standard Height Glazed Wall Unit

Range Specific Frames with Clear Glass						
Standard Glass Unit & MFC Shelves	400mm	WG40*	£227	500mm	WG50*	£249
c/w Sirius LED Lights & Glass Shelves	400mm	WG40SIR*	£293	500mm	WG50SIR*	£317
c/w Halo LED Downlights	400mm	WG40LED*	£324	500mm	WG50LED*	£348
c/w Edge Lit Shelves	-	-	-	500mm	WG50LSH*	£356
Aluminium Frame with Reflective Glass						
c/w Reflective Glass & MFC Shelves	400mm	WG40RFL	£216	500mm	WG50RFL	£238
c/w Reflective Glass & Sirius LED Downlights	400mm	WG40RFLSIR*	£273	500mm	WG50RFLSIR*	£297
c/w Reflective Glass & Halo LED Downlights	400mm	WG40RFLLED*	£300	500mm	WG50RFLLED*	£324
c/w Reflective Glass & Edge Lit Shelves	--	-	-	500mm	WG50RFLLSH*	£331

* Not available in Fusion Painted, Fusion Gloss & Concept Painted. These glazed wall units are supplied with glass shelves.

TALL HEIGHT GLAZED WALL UNITS (900mm)

Tall Height Glazed Wall Unit

Range Specific Frames with Clear Glass						
Standard Tall Glass Unit & MFC Shelves	500mm	TWG50*	£265	500mm	TWG50SIR*	£333
c/w Sirius LED Lights & Glass Shelves	500mm	TWG50SIR*	£333	500mm	TWG50LED*	£364
c/w Halo LED Downlights	500mm	TWG50LED*	£364	500mm	TWG50LSH*	£372
c/w Edge Lit Shelves	500mm	TWG50LSH*	£372	-	-	-
Aluminium Frame with Reflective Glass						
c/w Reflective Glass & MFC Shelves	500mm	TWG50RFL	£263	500mm	TWG50RFLSIR*	£315
c/w Reflective Glass & Sirius LED Downlights	500mm	TWG50RFLSIR*	£315	500mm	TWG50RFLLED*	£349
c/w Reflective Glass & Halo LED Downlights	500mm	TWG50RFLLED*	£349	500mm	TWG50RFLLSH*	£356
c/w Reflective Glass & Edge Lit Shelves	500mm	TWG50RFLLSH*	£356	-	-	-

* Tall units are only available in Gloss Stone Shaker, Classic Painted, Davenport Painted & Davenport Platinum White. These glazed wall units are supplied with glass shelves.

Please refer to page 62 for illustrations of range specific glazed doors.

BI-FOLD GLAZED WALL UNITS (720mm)

Bi-fold Unit

c/w Letterbox Style on bottom fascia			
600mm WBF60/LB	900mm WBF90/LB	£562	£660
800mm WBF80/LB		£639	

Please note: This unit is only available in Fusion Painted & Fusion Gloss.

DRESSER HEIGHT GLAZED WALL UNITS (1207mm)

Dresser Height Glazed Unit

Please note: Not available in Fusion Gloss, Fusion Painted & Concept Painted.

Range Specific Frames with Clear Glass			
Standard Dresser Glazed Unit & MFC Shelves	500mm	DR50	£284
c/w Sirius LED Lights & Glass Shelves	500mm	DR50SIR*	£383
c/w Halo LED Downlights	500mm	DR50LED*	£411
c/w Edge Lit Shelves	500mm	DR50LSH*	£480

These glazed wall units are supplied with glass shelves.



ACCESSORY BASE/WALL UNITS

Open Unit	Wine Rack
500/720/300mm WOP50 £114	Standard 150/720/300mm WR15 £72 Tall 150/900/300mm TWR15 £80

EURO HEIGHT UNITS

Type 1 Single Oven Housing Highline	Type 2 Single Oven Housing Drawerline	Type 3 Single Oven Housing	Type 6 Double Oven Housing	Type 8 Microwave/Steam Oven/coffee Machine Housing	Type 9 Microwave/Steam Oven/coffee Machine Housing	Type 10 Microwave/Steam Oven/coffee Machine Housing	Type 11 Microwave/Steam Oven/coffee Machine Housing	Type 1 Fridge/Freezer Housing	Type 1 Pantry Unit
600/1492mm EOH60 T1 £289	600/1492mm EOH60 T2 £383 (£440)	c/w 3 Drawers 600/1492mm EOH60 T3 £569 (£776)	c/w 2 Drawers 600/1492mm EOH60 T6 £413 (£545)	EOH60 T8 £396 (£453)	EOH60 T9 £688 (£953)	EOH60 T10 £414 (£471)	EOH60 T11 £707 (£971)	c/w 2 Drawers 600/1492mm EFH60 T1 £571 (£704)	c/w 2 Drawers 600/1492mm EP60 T1 £581 (£713)

APPLIANCE AND TALL UNITS

Tandem Larder Unit	Tandem Solo Unit	Convoy Premio Unit <i>(illus rh)</i>	Larder Unit	Double Larder Unit	Larder Unit c/w Pull Out Wirework	Type 1 Pullout Larder Unit	Type 2 Pullout Larder Unit
500/2117mm LUS0TDM £1,317	600/2117mm LUG0SOLO £1,170	600/2117mm (L/H) LUG0CONVL £1,533 600/2117mm (R/H) LUG0CONVR £1,533	300/2117mm LU30 £512 400/2117mm LU40 £529	1000/2117mm LU100 £1,205	With Arena Shelves Standard 300/2117mm LU30A £1,132 400/2117mm LU40A £1,240 500/2117mm LUS0A £1,349	With Graphite Wirework Standard 300/2117mm LU30B £1,250 400/2297mm LU40B £1,371 500/2297mm LUS0B £1,491	c/w 3 Pan Drawers, 4 Internal Drawers Standard 300/2117mm LU30P T1 £1,003 400/2117mm LU40P T1 £1,047 500/2117mm LUS0P T1 £1,089
Tall 500/2297mm TLUS0TDM £1,345	with Graphite Wirework 600/2117mm LUG0BSOLO £1,292	with Graphite Wirework 600/2117mm (L/H) LUG0BCONVL £1,693 600/2117mm (R/H) LUG0BCONVR £1,693	Tall 500/2297mm TLUS0 £546 600/2117mm LUG0 £591	Tall 1000/2297mm TLU100 £1,280	Tall 300/2297mm TLU30A £1,175 400/2297mm TLU40A £1,290 500/2297mm TLU50A £1,404	Tall 300/2297mm TLU30B £1,299 400/2297mm TLU40B £1,426 500/2297mm TLU50B £1,551	c/w 2 Pan Drawers, 3 Internal Drawers Standard 300/2117mm TLUS0P T2 £858 400/2117mm TLUS0P T2 £894 500/2117mm TLUS0P T2 £930

APPLIANCE AND TALL UNITS

Type 3 Larder Unit	Type 4 Larder Unit	Type 1 1000 Corner Larder to Larder	Type 2 1000 Corner Larder to Larder with Le-Mans Pull Out Storage	Type 3 1000 Corner Larder to Base
c/w 6 Internal Drawers Standard 300/2117mm LU30P T3 £1,048 (£1,278) 400/2117mm LU40P T3 £1,092 (£1,354) 500/2117mm LUS0P T3 £1,135 (£1,421) 600/2117mm LUG0P T3 £1,229 (£1,545)	Tall 300/2297mm TLUS0P T3 £1,068 (£1,298) 400/2297mm TLU40P T3 £1,112 (£1,374) 500/2297mm TLUS0P T3 £1,157 (£1,443)	c/w 4 Internal Drawers Standard 300/2117mm LU30P T4 £858 (£1,012) 400/2117mm LU40P T4 £893 (£1,068) 500/2117mm LUS0P T4 £927 (£1,118) 600/2117mm LUG0P T4 £1,072 (£1,282)	400/2117mm LUC104T1 £705 500/2117mm LUC105T1 £828 600/2117mm LUC106T1 £837 Tall 400/2297mm TLUC104T1 £713 500/2117mm TLUC105T1 £744	with Graphite Wirework 500/2117mm (L/H) LUCB105T2L £2,162 500/2117mm (R/H) LUCB105T2R £2,162 600/2117mm (L/H) LUCB106T2L £2,269 600/2117mm (R/H) LUCB106T2R £2,269 Tall 400/2297mm TLUCB105T2L £2,200 500/2297mm (R/H) TLUCB105T2R £2,200

* Larder to larder units do not include a blanking panel.

APPLIANCE AND TALL UNITS

Type 4 1000 Corner Larder to Base with Le-Mans Pull Out Storage	Type 5 1000 Corner Larder to Base with planked end panel	Type 6 1000 Corner Larder to Base with planked end panel & Le-Mans Pull Out Storage	1000 Butler's Larder with Wine Racks
with Graphite Wirework 500/2117mm (L/H) LUC105 T4L £2,140 500/2117mm (R/H) LUC105 T4R £2,140 600/2117mm (L/H) LUC106 T4L £2,237 600/2117mm (R/H) LUC106 T4R £2,237	500/2117mm (L/H) LUCB105 T4L £2,365 500/2117mm (R/H) LUCB105 T4R £2,365 600/2117mm (L/H) LUCB106 T4L £2,472 600/2117mm (R/H) LUCB106 T4R £2,472	400/2117mm LUC104 T5 £942 500/2117mm LUC105 T5 £987 600/2117mm LUC106 T5 £1,033 Tall 400/2297mm TLUC104 T5 £979 500/2297mm (L/H) TLUC105 T4L £2,174 500/2297mm (R/H) TLUC105 T4R £2,174	with Graphite Wirework 500/2117mm (L/H) LUCB105 T6L £2,322 500/2117mm (R/H) LUCB105 T6R £2,322 600/2117mm (L/H) LUCB106 T6L £2,427 600/2117mm (R/H) LUCB106 T6R £2,427
500/2117mm (L/H) LUC105 T6L £2,322 500/2117mm (R/H) LUC105 T6R £2,322 600/2117mm (L/H) LUC106 T6L £2,427 600/2117mm (R/H) LUC106 T6R £2,427	500/2117mm (L/H) LUCB105 T6L £2,566 500/2117mm (R/H) LUCB105 T6R £2,566 600/2117mm (L/H) LUCB106 T6L £2,682 600/2117mm (R/H) LUCB106 T6R £2,682	500/2297mm (L/H) TLUC105 T6L £2,359 500/2297mm (R/H) TLUC105 T6R £2,359	1000/2117mm LU100BUT £1,259 1000/2297mm TLU100BUT £1,316

Please note: This unit is only available on Lissa Oak cabinet.

BUTLERS LARDER ACCESSORY ITEMS

	Two 200 x 200mm Oak Boxes BOX200K £56
	Oak Framed Wicker Basket with runners (To suit 500 wide unit) WKBASKOK £145
	Two Small Wicker Baskets (225x250x150mm) WKBASML £79
	Oak Door Rack OAKSPICE35 £318



Price Group 3

Davenport Platinum White Shaker Gloss Fusion Gloss
 Classic Painted Fusion Painted Davenport Painted
 Concept Painted

(Price shown in brackets denotes full unit price with oak drawers. Oak drawers not available in Fusion or Concept Painted.)
 Please note Tall Units are available in all Group 3 ranges.

APPLIANCE AND TALL UNITS

Built Under Oven Housing	Built Under Oven Housing with drawer	Type 1 Double Oven Housing	Type 2 Double Oven Housing	Type 3 Double Oven Housing	Type 5 Single Oven/Microwave Unit	Type 6 Single Oven Housing	Type 7 Single Oven Housing	Type 8 Single Oven Housing	Type 9 Microwave/Steam Oven/coffee Machine Housing	Type 10 Microwave/Steam Oven/coffee Machine Housing	Type 11 Microwave/Steam Oven/coffee Machine Housing
600mm BUOH £122	600mm BUOHD £201	600/2117mm OH60 T1 £471 Tall 600/2297mm TOH60 T1 £488	c/w 2 Drawers 600/2117mm OH60 T2 £636 (£785) Tall 600/2297mm TOH60 T2 £652 (£802)	c/w 3 Drawers 600/2117mm OH60 T3 £718 (£908) Tall 600/2297mm TOH60 T3 £734 (£924)	600/2117mm OH60 T5 £444 Tall 600/2297mm TOH60 T5 £488	600/2117mm OH60 T6 £582 (£639) Tall 600/2297mm TOH60 T6 £598 (£655)	600/2117mm OH60 T7 £688 (£803) Tall 600/2297mm TOH60 T7 £705 (£819)	600/2117mm OH60 T8 £874 (£1,139) Tall 600/2297mm TOH60 T8 £891 (£1,155)	600/2117mm OH60 T9 £701 (£816) Tall 600/2297mm TOH60 T9 £717 (£832)	600/2117mm OH60 T10 £630 (£780) Tall 600/2297mm TOH60 T10† £702 (£852)	600/2117mm OH60 T11† £649 (£798) Tall 600/2297mm TOH60 T11 £707 (£857)

† Supplied with Stainless Steel filler

APPLIANCE AND TALL UNITS

Type 12 Microwave/Steam Oven/coffee Machine Housing	Type 13 Microwave/Steam Oven/coffee Machine Housing	Type 1 Fridge/Freezer Housing	Type 2 Fridge/Freezer Housing	Type 5 Fridge & Freezer Housing	Type 6 Combi Fridge/Freezer Housing (Tall unit illustrated)	Type 8 Combi Fridge/Freezer Housing
600/2117mm OH60 T12 £465 Tall 600/2297mm TOH60 T12† £540	600/2117mm OH60 T13† £484 Tall 600/2297mm TOH60 T13 £545	600/2117mm FFH60 T1 £637 Tall 600/2297mm TFFH60 T1 £654	c/w 2 Drawers 600/2117mm FFH60 T2 £794 (£944) Tall 600/2297mm TFFH60 T2 £811 (£960)	600/2117mm FFH60 T5 £577 Tall 600/2297mm TFFH60 T5 £619	600/2117mm FFH60 T6 £571 Tall* 600/2297mm TFFH60 T8 £630	

† Supplied with Stainless Steel filler

* Please refer to fascia matrix on page 69 & page 99 for layout of doors.

INTEGRATED APPLIANCE FASCIAS

Semi Integrated Dishwasher Fascia	Highline Integrated Fridge/Freezer Fascia	Drawerline Integrated Fridge/Freezer Fascia	Integrated Hood Fascia	Highline Dishwasher Fascia	Drawerline Dishwasher Fascia
600/572mm IFS60 £115	600mm IF60FR £136	600mm IFD60FR £172	600/450mm IF60EXT £101	450mm Slimline IF45 £111 600mm Fully Integrated IF60DW £136	450mm Slimline IFD45 £144 600mm Fully Integrated IFD60DW £172



Accessories

Cornices & Pelmets	Traditional Cornice Painted/PVC Wrapped (H - 56mm)	Traditional Cornice PVC Wrapped (H - 70mm)	Square section Cornice/Pelmet/Pilaster (H - 36mm)	Curved Cornice Painted (H - 56mm) External	Traditional Internal Curved Section (H-56mm)	External Curved Cornice/Pelmet (H - 36mm)	Internal Curved Section (H-36mm) Square
Fusion Gloss White	1750mm 3600mm	1750mm 3600mm	1750mm 3600mm				
Fusion Gloss Ivory			CBPAIGWH £46			CBCVJGW £127	CBCUGW £126
Fusion Gloss Grey			CBPAIGVH £46			CBCVJGV £127	CBCUGV £126
Fusion Gloss Anthracite			CBPAIGYH £46			CBCVJGY £127	CBCUGY £126
Fusion Gloss Light Grey			CBPAIGAH £46			CBCVJGA £127	CBCUGA £126
Fusion Gloss Cashmere			CBPAIGLH £46			CBCVJGL £127	CBCUGL £126
Fusion Gloss Limestone			CBPAIGCH £46			CBCVJGC £127	CBCUGC £126
Gloss Stone Shaker		TCPVCSTH £71	TCPVCST £112			CBCVJGS £127	CBCUGS £126
Davenport Painted - all colours*	TCPAT H £47	TCPAT £84	CBMAT H £66			CBCVST £126	
Classic Painted - all colours*	TCPAT H £47	TCPAT £84	CBMAT H £66		TCCV £187	CBCV £126	CBCI £126
Fusion Painted - all colours*			CBMAT H £66		TCCV £187	CBCV £126	CBCI £126
Concept Painted - all colours*			CBMAT H £66		TCCV £187	CBCVJP £126	CBCIJP £126

Cornices & Pelmets cont'd	External Corner Post (Solo Only)	2.4m Curved Corner Section 100mm Wide	938mm Curved Corner Section 50mm Wide	1387mm Curved Corner Section 50mm Wide	100mm Graphite Wide Cornice/Pelmet/Filler 2400 x 100 MFC	Traditional Curved Cornice Corner Block (H-56mm)	Traditional Corner Block 90° (H-56mm)	Corbel
Fusion Gloss White	L/Hand R/Hand							
Fusion Gloss Ivory								
Fusion Gloss Grey								
Fusion Gloss Anthracite								
Fusion Gloss Light Grey								
Fusion Gloss Cashmere								
Fusion Gloss Limestone								
Gloss Stone Shaker		CCSST £194						
Davenport Painted - all colours*			CCSBW £55	CCSDT £77		CCSTC £77	TCCB £49	CORMAT £109
Classic Painted - all colours*			CCSBW £55	CCSDT £77		CCSTC £77	TCCB £49	CORMAT £109
Fusion Painted - all colours*	ECPLHJP £164	ECPRHJP £164	CCSBW £55	CCSDT £77		CCSTC £77	TCCB £49	CORMAT £109
Concept Painted - all colours*								

◆ Fusion Painted Curved Pelmet, External Corner Post & Deco Panel colours: (B) Blue, (L) Lt Grey, (O) Oyster, (R) Green, (T) White, (U) Cashmere, (V) Ivory, (Y) Sage, (H) Hickory, (S) Steel Blue, (X) Oxford Blue, (M) Limestone, (K) Anthracite, (J) Sandstone

* = Use colour code suffix to specify the colour of your accessory
 Davenport Painted, Fusion Painted, Concept Painted & Classic Painted

- (DB) Painted Light Blue
- (DO) Painted Oyster
- (DR) Painted Green
- (DT) Painted White
- (DV) Painted Ivory
- (DY) Painted Sage Grey
- (DL) Painted Light Grey
- (DU) Painted Cashmere
- (DH) Painted Hickory
- (DS) Painted Steel Blue
- (DX) Painted Oxford Blue
- (DM) Painted Limestone
- (DK) Painted Anthracite
- (DJ) Painted Sandstone

Decorative Accessories	Canopy † (Plain finish) 640 x 1105mm - can be cut down to 460 x 850mm	Base Corner Pilaster (Painted) (h920 w100mm)	Pilaster †† (w75mm)	Square Pilaster (h920 w100mm)
Davenport Painted - all colours*	CANOPYMAT £550	BCF £307	PILBMAT £174	PILSQMAT £307
Classic Painted - all colours*	CANOPYMAT £550	BCFD £307	PILBMAT £174	PILSQMAT £307
Concept Painted - all colours*	CANOPYMAT £550	BCF £307	PILBMAT £174	PILSQMAT £307

† Can take extractor flange size 380 x 730mm

†† Please note the White pilaster features a different design to the painted version

Prices include V.A.T. at 20%. Unit price excludes worktop and plinth. Illustrations are not truly representative, please refer to brochure.

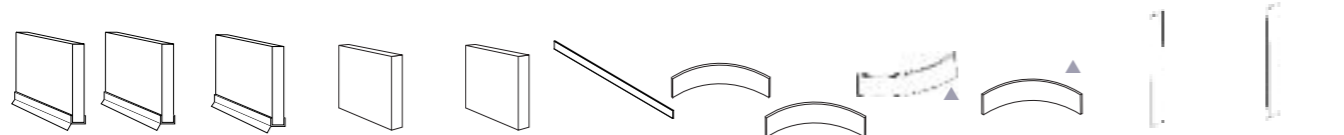

	2650mm Plinth (18mm MFC) Supplied with sealing strip	2650mm Plinth (16mm MFC) Aluminium effect	Graphite Plinth with Seal 150 x 2750	2550mm Plinth Gloss PVC	3000mm Plinth Painted	2650mm Mirrored Plinth	Curved External Mirrored Plinth	Curved Internal Mirrored Plinth	Curved Plinth External	Plinth Internal Curved Section	100mm Filler Panels 18mm MFC - 2297mm Edged 1 Long & 2 Short	100mm Filler Panels 18mm Aluminium - 2297mm Edged 1 Long & 2 Short	Filler Panel 2400 x 120mm (22mm Thick) Painted
Plinths													
Fusion Gloss White	PL1GW £34	PLAL £34	PLGR £34		PLPAIGW £133	PLMIR £84	PLCMIR £183	PLCV93MIR £175	PLCVPGW £118	PLCV93GW £130	TF1GW £30	TF1AL £30	
Fusion Gloss Ivory	PL1GI £34	PLAL £34	PLGR £34		PLPAIGV £133	PLMIR £84	PLCMIR £183	PLCV93MIR £175	PLCVGV £105	PLCV93GV £130	TF1GI £30	TF1AL £30	
Fusion Gloss Grey		PLAL £34	PLGR £34		PLPAIGY £133	PLMIR £84	PLCMIR £183	PLCV93MIR £175	PLCVGY £105	PLCV93GY £130		TF1AL £30	
Fusion Gloss Anthracite		PLAL £34	PLGR £34		PLPAIGA £133	PLMIR £84	PLCMIR £183	PLCV93MIR £175	PLCVGA £105	PLCV93GA £130		TF1AL £30	
Fusion Gloss Light Grey		PLAL £34	PLGR £34		PLPAIGL £133	PLMIR £84	PLCMIR £183	PLCV93MIR £175	PLCVGL £105	PLCV93GL £130		TF1AL £30	
Fusion Gloss Cashmere		PLAL £34	PLGR £34		PLPAIGC £133	PLMIR £84	PLCMIR £183	PLCV93MIR £175	PLCVGC £105	PLCV93GC £130	TF1GC £30	TF1AL £30	
Fusion Gloss Limestone		PLAL £34	PLGR £34		PLPAIGS £133	PLMIR £84	PLCMIR £183	PLCV93MIR £175	PLCVGS £105	PLCV93GS £130		TF1AL £30	
Gloss Stone Shaker	PL1ST £34	PLAL £34	PLGR £34	PLPVCST £107		PLMIR £84	PLCMIR £183	PLCVST1 £105		TF1ST £30		TF1AL £30	
Davenport Painted - all colours*		PLAL £34	PLGR £34		PLMAT £84	PLMIR £84	PLCMIR £183	PLCV £118				TFMAT £72	
Classic Painted - all colours*		PLAL £34	PLGR £34		PLMAT £84	PLMIR £84	PLCMIR £183	PLCV93MIRT1 £193	PLCV £118	PLCV93 £129		TFMAT £72	
Fusion Painted - all colours*		PLAL £34	PLGR £34		PLMAT £84	PLMIR £84	PLCMIR £183	PLCV93MIR £193	PLCV £118	PLCV93 £129		TFMAT £72	
Concept Painted - all colours*		PLAL £34	PLGR £34		PLMAT £84	PLMIR £84	PLCMIR £183					TFMAT £72	

(▲ = Curved Plinth sections for use with Painted/PVC Plinths only)

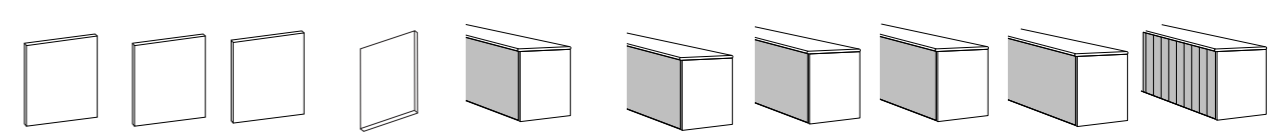

	Multi Purpose Panel 2347 x 670 MFC	Multi Purpose Panel 2347 x 670 Aluminium	Multi Purpose Panel 2347 x 670 PVC Gloss	Graphite Multi Purpose Panel/Larder Add On End Panel 2400 x 670 MFC	Breakfast Bar Back Panel 940 x 2010 Gloss MFC (Edged 1L, 1S)	Breakfast Bar Back Panel 940 x 2010 Aluminium (Edged 1L, 1S)	Breakfast Bar Back Panel 890 x 2050 PVC Gloss	Breakfast Bar Back Panel 890 x 2050 Gloss Lacquered/Painted	Graphite Breakfast Bar Back Panel 940 x 2010 MFC	Planked Breakfast Bar Back Panel 890 x 2050 Painted
Panels cont'd										
Fusion Gloss White	MPP1GW £111	MPP1AL £111	MPP1GR £111	MPP1GR £111	BBBP1GW £116	BBBP1AL £87			BBBPPAIGW2† £398	BBBP1GR £87
Fusion Gloss Ivory	MPP1GI £111	MPP1AL £111	MPP1GR £111	MPP1GR £111	BBBP1GI £116	BBBP1AL £87			BBBPPAIGV2† £398	BBBP1GR £87
Fusion Gloss Grey		MPP1AL £111	MPP1GR £111	MPP1GR £111		BBBP1AL £87			BBBPPAIGY2† £398	BBBP1GR £87
Fusion Gloss Anthracite		MPP1AL £111	MPP1GR £111	MPP1GR £111		BBBP1AL £87			BBBPPAIGA† £398	BBBP1GR £87
Fusion Gloss Light Grey		MPP1AL £111	MPP1GR £111	MPP1GR £111		BBBP1AL £87			BBBPPAIGL2† £398	BBBP1GR £87
Fusion Gloss Cashmere	MPP1GC £111	MPP1AL £111	MPP1GR £111	MPP1GR £111	BBBP1GC £116	BBBP1AL £87			BBBPPAIGC2† £398	BBBP1GR £87
Fusion Gloss Limestone		MPP1AL £111	MPP1GR £111	MPP1GR £111		BBBP1AL £87			BBBPPAIGS2† £398	BBBP1GR £87
Gloss Stone Shaker	MPP1ST £111	MPP1AL £111	MPP1GR £111	MPP1GR £111	BBBP1ST £116	BBBP1AL £87	BBBPPVCST1 £316			BBBP1GR £87
Davenport Painted - all colours*		MPP1AL £111	MPP1GR £111	MPP1GR £111		BBBP1AL £87			BBBPMAT £217	BBBP1GR £87
Classic Painted - all colours*		MPP1AL £111	MPP1GR £111	MPP1GR £111		BBBP1AL £87			BBBPMAT £217	BBBP1GR £87
Fusion Painted - all colours*		MPP1AL £111	MPP1GR £111	MPP1GR £111		BBBP1AL £87			BBBPMAT £217	BBBP1GR £87
Concept Painted - all colours*		MPP1AL £111	MPP1GR £111	MPP1GR £111		BBBP1AL £87			BBBPMAT £217	BBBP1GR £87

† Comes in 2 Pieces

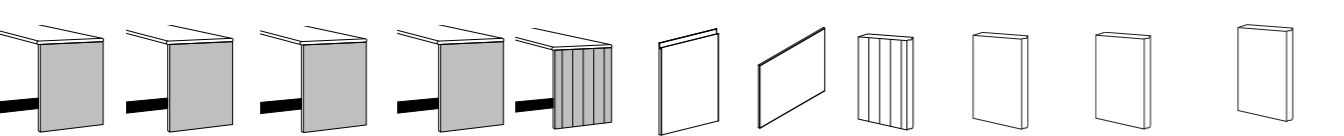

	End Support Panel 920 x 670mm MFC	End Support Panel 890 x 670mm Aluminium	End Support Panel 890 x 670mm Gloss Lacquered/Painted	End Support Panel 920 x 670mm PVC Gloss	Planked Add on Base End Panel 890 x 670 Painted Profiled front edge	Deco Panel 720 x 768mm (for use with ECPRH & ECPHL)	Island End Panel 716 x 860mm	Planked Add On Wall End Panel 1584 x 375 Painted Profiled front edge	Add On Wall End Panel 1584 x 375 Gloss Lacquered/Painted	Add On Housing End Panel 2347 x 670 Gloss Lacquered/Painted	Graphite End Support Panel/Add on Base End Panel 940 x 670 MFC	Planked Add on Housing End Panel 2400 x 670 Painted Profiled front edge
Panels												
Fusion Gloss White	ESP1GW £34	ESP1AL £34	ESPPAIBGW £146		DEPIGW £121			EPPAIWGW £147	EPPAIHGW £375	ESP1GR £34		
Fusion Gloss Ivory	ESP1GI £34	ESP1AL £34	ESPPAIBGV £146		DEPIGI £121			EPPAIWGV £147	EPPAIHGV £375	ESP1GR £34		
Fusion Gloss Grey		ESP1AL £34	ESPPAIBGY £146		DEPIGY £121			EPPAIWGY £147	EPPAIHGY £375	ESP1GR £34		
Fusion Gloss Anthracite		ESP1AL £34	ESPPAIBGA £146		DEPIGA £121			EPPAIWGA £147	EPPAIHGA £375	ESP1GR £34		
Fusion Gloss Light Grey		ESP1AL £34	ESPPAIBGL £146		DEPIGL £121			EPPAIWGL £147	EPPAIHGL £375	ESP1GR £34		
Fusion Gloss Cashmere	ESP1GC £34	ESP1AL £34	ESPPAIBGC £146		DEPIGC £121			EPPAIWGC £147	EPPAIHGC £375	ESP1GR £34		
Fusion Gloss Limestone		ESP1AL £34	ESPPAIBGS £146		DEPIGS £121			EPPAIWGS £147	EPPAIHGS £375	ESP1GR £34		
Gloss Stone Shaker	ESP1ST £34	ESP1AL £34		ESPPVCST1 £118						ESP1GR £34		
Davenport Painted - all colours*		ESP1AL £34	ESPMATB £111		ESPLKB £115			EPPLKW £115	EPMATW £111	EPMATH £211	ESP1GR £34	EPPLKH £235
Classic Painted - all colours*		ESP1AL £34	ESPMATB £111		ESPLKB £115			EPPLKW £115	EPMATW £111	EPMATH £211	ESP1GR £34	EPPLKH £235
Fusion Painted - all colours*		ESP1AL £34	ESPMATB £111		DEPIP £128	IEPMAT £84			EPMATW £111	EPMATH £211	ESP1GR £34	
Concept Painted - all colours*		ESP1AL £34	ESPMATB £111						EPMATW £111	EPMATH £211	ESP1GR £34	

(EPMATH panels are 2400mm high)



	Edging Tape 10m PVC Unglued	10 Metre Roll of Graphite Edging Tape	Edging Tape 5m PVC Unglued (1.3mm thick)	10 Metre Aluminium Edging Tape - Unglued PVC	5 Metre Roll Graphite Edging Tape (1.3mm thick)	5 Metre Aluminium Edging Tape - Unglued PVC (1.3mm thick)
Edging Tapes						
Fusion Gloss White	ETGW £17	ETGR £17	ETSGW £26	ETAL £17	ETSGR £26	ETSAL £26
Fusion Gloss Ivory	ETGI £17	ETGR £17	ETSGI £26	ETAL £17	ETSGR £26	ETSAL £26
Fusion Gloss Grey		ETGR £17		ETAL £17	ETSGR £26	ETSAL £26
Fusion Gloss Anthracite		ETGR £17		ETAL £17	ETSGR £26	ETSAL £26
Fusion Gloss Light Grey		ETGR £17		ETAL £17	ETSGR £26	ETSAL £26
Fusion Gloss Cashmere	ETGC £17	ETGR £17	ETSGC £26	ETAL £17	ETSGR £26	ETSAL £26
Fusion Gloss Limestone		ETGR £17		ETAL £17	ETSGR £26	ETSAL £26
Gloss Stone Shaker	ETST £17	ETGR £17	ETSS £26	ETAL £17	ETSGR £26	ETSAL £26
Davenport Painted - all colours*		ETGR £17		ETAL £17	ETSGR £26	ETSAL £26
Classic Painted - all colours*		ETGR £17		ETAL £17	ETSGR £26	ETSAL £26
Fusion Painted - all colours*		ETGR £17		ETAL £17	ETSGR £26	ETSAL £26
Concept Painted - all colours*		ETGR £17		ETAL £17	ETSGR £26	ETSAL £26

† Comes in 2 Pieces

* = Use colour code suffix to specify the colour of your accessory

Davenport Painted, Fusion Painted, Concept Painted & Classic Painted

- (DB) Painted Light Blue
- (DO) Painted Oyster
- (DR) Painted Green
- (DT) Painted White
- (DV) Painted Ivory
- (DY) Painted Sage Grey
- (DL) Painted Light Grey
- (DU) Painted Cashmere
- (DH) Painted Hickory
- (DS) Painted Steel Blue
- (DX) Painted Oxford Blue
- (DM) Painted Limestone
- (DK) Painted Anthracite
- (DJ) Painted Sandstone

Single Base Unit	Double Base Unit	Belfast Sink Base Unit	Breakfront Unit with Shelf (R/H illus)	Breakfront Unit with Pull Out Wirework (R/H illus)	Base Unit with 2 Pull Out Arena Shelves	Base Unit with Pull Out Chrome Wine Rack	Base with 2 Pull Out Wirework	Base Unit with 2 Pull Out Wirework and Stainless Steel Fascia	Base c/w 2 (140mm deep) Veg Baskets	Type 2 Pullout	Type 3 Pullout c/w 2 Internal Drawers
150mm BU15H £122 300mm BU30 £209 400mm BU40 £215 450mm BU45 £219 500mm BU50 £219 600mm BU60 £263	800mm BU80 £391 900mm BU90 £397 1000mm BU100 £397	600mm BEL60 £215	300mm BFR530 £231	300mm c/w Arena Shelves L/H BFR30LA £434 300mm c/w Arena Shelves R/H BFR30RA £434	300mm B30AW £433 with Graphite Wirework 300mm B30BW £478	400mm B40WRL £567 400mm B40WRR £567	150mm BU15 £297 with Graphite Wirework 150mm BU15B £328	150mm BU155S £344 with Graphite Wirework 150mm BU15BSS £380	400mm B40V £319 500mm B50V £338 600mm B60V £386	300mm B30PT2 £332 400mm B40PT2 £343 450mm B45PT2 £349 500mm B50PT2 £353 600mm B60PT2 £402	300mm B30PT3 £391 (£468) 400mm B40PT3 £404 (£492) 450mm B45PT3 £414 (£505) 500mm B50PT3 £419 (£514) 600mm B60PT3 £470 (£575)

Base Unit with Le-Mans Pull Out Storage* (L/H illus)	Corner Base Unit* (L/H illus)	L Shaped Corner Base Unit	Corner Carousel Base Unit* (L/H illus)	Corner Base Unit c/w Vario Pull Out Storage* (R/H illus)	L Shaped Corner Carousel Base Unit	Curved L Shaped Corner Base Unit
900mm L/H c/w 450mm door BCC145ML £939 1000mm L/H c/w 500mm door BCC100ML £971 1000mm L/H c/w 600mm door BCC160ML £1,035 900mm R/H c/w 450mm door BCC145MR £939 1000mm R/H c/w 500mm door BCC100MR £971 1000mm R/H c/w 600mm door BCC160MR £1,035	with Graphite Wirework 900mm L/H c/w 450mm door BCCB145ML £1,037 1000mm L/H c/w 500mm door BCCB100ML £1,073 1000mm L/H c/w 600mm door BCCB160ML £1,144 900mm R/H c/w 450mm door BCCB145MR £1,037 1000mm R/H c/w 500mm door BCCB100MR £1,073 1000mm R/H c/w 600mm door BCCB160MR £1,144	800mm c/w 400mm door BC80 £329 900mm c/w 450mm door BC90 £334 1000mm c/w 500mm door BC100 £334 1000mm c/w 600mm door BC120 £373	930/930mm c/w Arena Shelves BCC100A £606 1030/1030mm c/w Arena Shelves BCC103A £603 1000mm c/w 600mm door & Arena Shelves BCC120A £619	900mm L/H c/w Arena Shelves 450mm door BCM145LA £1,137 1000mm L/H c/w Arena Shelves 500mm door BCM100LA £1,148 1000mm L/H c/w Arena Shelves 600mm door BCM160LA £1,159 900mm R/H c/w Arena Shelves 450mm door BCM145RA £1,137 1000mm R/H c/w Arena Shelves 500mm door BCM100RA £1,148 1000mm R/H c/w Arena Shelves 600mm door BCM160RA £1,159	930/930mm c/w Arena Shelves BCC93A £754 930/930mm c/w Graphite Wirework BCC93B £833	930/930mm BCCU93/SHK £604 <i>Only on Matt Ivory, Lissa Oak, Sand Oak, Aluminium, cashmere (Matt & Gloss) or Platinum White cabinets</i> <i>Not in Fusion Shaker Gloss White</i>

* Corner base units do not include a blanking panel. The end support panel ESP can be used for this purpose if required.

Single Base Unit	Double Base Unit	Base Unit 1 Dummy Drawer	Base Unit Dummy Drawer	Base Unit 2 Dummy Drawers	Breakfront Unit with Shelf	Breakfront Unit with Pull Out Wirework (R/H illus)	Base Unit with 2 Pull Out Arena Shelves	Base Unit with Dummy Drawer & Pull Out Wine Rack	Base c/w 2 (140mm deep) Veg Baskets	Type 1 Pullout c/w 1 Pan Drawer, 1 Internal Drawer
300mm BD30 £298 (£342) 400mm BD40 £315 (£364) 450mm BD45 £320 (£371) 500mm BD50 £322 (£374) 600mm BD60 £366 (£423)	800mm BD80 £592 (£691) 900mm BD90 £601 (£703) 1000mm BD100 £605 (£710)	800mm BSD80 £525 (£574) 900mm BSD90 £532 (£583) 1000mm BSD100 £534 (£587)	300mm BDD30 £244 400mm BDD40 £259 450mm BDD45 £263 500mm BDD50 £263 600mm BDD60 £307	800mm BDD80 £480 900mm BDD90 £485 1000mm BDD100 £485	300mm BFR530D £275	300mm c/w Arena Shelves L/H BFR30DLA £463 300mm c/w Arena Shelves R/H BFR30DRA £463	300mm BDD30AW £423 with Graphite Wirework BDD40WRL £552 300mm BDD30BW £467	400mm BDD40WRR £552 400mm BDD40WRL £552	400mm BD40V £391 (£437) 500mm BD50V £411 (£461) 600mm BD60V £457 (£511)	300mm BD30PT1 £443 400mm BD40PT1 £466 450mm BD45PT1 £476 500mm BD50PT1 £482 600mm BD60PT1 £534

Corner Base Unit* (L/H illus)	L Shaped Corner Base Unit	Corner Carousel Base Unit* (L/H illus)	Corner Base Unit c/w Vario Pull Out Storage* (R/H illus)	L Shaped Corner Carousel Base Unit	Base Unit with Le-Mans Pull Out Storage* (L/H illus)
800mm c/w 400mm door BCD80 £423 (£473) 900mm c/w 450mm door BCD90 £431 (£482) 1000mm c/w 500mm door BCD100 £433 (£485) 1000mm c/w 600mm door BCD120 £471 (£529)	930/930mm BCD93 £647 1030/1030mm BCD103 £660	1000mm c/w 500mm door & Arena Shelves BCCD10A £606 (£655) 1000mm c/w 600mm door & Arena Shelves BCCD12A £619 (£673)	900mm L/H c/w 450mm door & Arena Shelves BCM14LA £1,232 (£1,280) 900mm R/H c/w 450mm door & Arena Shelves BCM14RA £1,232 (£1,280)	1000mm L/H c/w 500mm door & Arena Shelves BCM10LA £1,245 (£1,294) 1000mm R/H c/w 500mm door & Arena Shelves BCM10RA £1,245 (£1,294)	1000mm L/H c/w 600mm door & Arena Shelves BCM16LA £1,260 (£1,314) 1000mm R/H c/w 600mm door & Arena Shelves BCM16RA £1,260 (£1,314)

* Corner base units do not include a blanking panel. The end support panel ESP can be used for this purpose if required.

5 Drawer Pack	4 Pan Drawer Pack	3 Pan Drawer Pack	2 Drawer Unit	2 Drawer Unit c/w Internal Drawer	Base with 1 Drawer and 2 Wicker Baskets	Sink Pan Drawer Unit 1 Dummy drawer 1 Cut out drawer option
300mm DP30 £620 (£841) 400mm DP40 £684 (£930) 450mm DP45 £697 (£952) 500mm DP50 £706 (£968) 600mm DP60 £758 (£1,044) 800mm DP80 £1,002 (£1,320) 900mm DP90 £1,008 (£1,346) 1000mm DP100 £1,085 (£1,436)	500mm PD50/4 £616 (£842) 600mm PD60/4 £658 (£905) 800mm PD80/4 £866 (£1,147) 900mm PD90/4 £900 (£1,184) 1000mm PD100/4 £968 (£1,260)	500mm PD50/3 £525 (£716) 600mm PD60/3 £558 (£765) 800mm PD80/3 £731 (£974) 900mm PD90/3 £792 (£1,021) 1000mm PD100/3 £851 (£1,084)	600mm PD60/2 £436 (£586) 800mm PD80/2 £504 (£684) 900mm PD90/2 £557 (£719) 1000mm PD100/2 £594 (£757)	600mm PDT60/2 £533 800mm PDT80/2 £611 900mm PDT90/2 £667 1000mm PDT100/2 £709	500mm WB50 £326 (£375) Oak option 500mm WB50/OAK £476 (£525)	900mm PDS90/3 £720 2 Cut out drawer option 900mm PDS90/3P2 £732

Curved End Base Unit	Single Base Unit
300mm c/w 1 door & 1 shelf CE8301 £499	260mm Base Unit BU26 £157

Please refer to special worktop planning guidelines on page 78.

Single Wall Unit	Double Wall Unit	Dresser Unit with Solid Door	Wall Bridging Unit	Double Wall Bridging Unit	Microwave Unit	Up & Over Flap Unit	Bi-Fold Wall Bridging Unit
Standard 150/720mm WU15 £154 300/720mm WU30 £196 400/720mm WU40 £202 450/720mm WU45 £208 500/720mm WU50 £212 600/720mm WU60 £256	Tall 300/900mm TWU30 £211 400/900mm TWU40 £217 450/900mm TWU45 £223 500/900mm TWU50 £227 600/900mm TWU60 £305	Standard 600/720mm (c/w 2 doors) WU60/2 £339 800/720mm WU80 £407 900/720mm WU90 £415 1000/720mm WU100 £423	Tall 600/900mm (c/w 2 doors) TWU60/2 £359 800/900mm TWU80 £430 900/900mm TWU90 £438 1000/900mm TWU100 £449	500/1207mm DR50/SL £254	600/288mm WBG60 £201 900/288mm WBG90 £288	600/576mm WDBG60 £373 900/576mm WDBG90 £496	600/720mm WU60/MW £334 900/720mm WU60/VR £400 600/720mm WU60/VR £400 900/720mm WU60/VR £400

Note: 190mm height clearance required.
Do not use in corner with WC60.
See page 47 for details of which cornice cannot be used with this unit.
Note: 190mm height clearance required.

L Shaped Corner Wall Unit	Standard Corner Wall Unit	260mm Wall Unit	Curved End Wall Unit	L Curved Internal Wall Unit
Standard 630/630/720mm WCL630 £511	WC60 £317	260/720mm c/w 1 door & 1 adjustable shelf WU26 £162	300/300mm c/w 1 door & 1 adjustable shelf CEW301 £515	670/670mm c/w 1 door & 2 adjustable shelves WCCU67/SHK £558 <i>Only on Matt Ivory, Lissa Oak, Sand Oak Wood, Cashmere (Matt & Gloss) or Platinum White cabinets</i> <i>Not in Fusion Shaker Gloss White</i> <i>Refer to special planning guidelines on page 78.</i>



STANDARD HEIGHT GLAZED WALL UNITS (1720mm)

Standard Height Glazed Wall Unit

Range Specific Frames with Glass			
Standard Glass Unit & MFC Shelves	400mm	WG40	£254
c/w Sirius LED Lights & Glass Shelves	400mm	WG40SIR	£321
c/w Halo LED Downlights	400mm	WG40LED	£352
c/w Edge Lit Shelves	-	-	-
Aluminium Frame with Reflective Glass			
c/w Reflective Glass & MFC Shelves	400mm	WG40RFL	£216
c/w Reflective Glass & Sirius LED Downlights	400mm	WG40RFLSIR	£273
c/w Reflective Glass & Halo LED Downlights	400mm	WG40RFLLED	£300
c/w Reflective Glass & Edge Lit Shelves	-	-	-

These glazed wall units are supplied with glass shelves

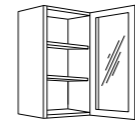

TALL HEIGHT GLAZED WALL UNITS (900mm)

Tall Height Glazed Wall Unit

Range Specific Frames with Glass			
Standard Tall Glass Unit & MFC Shelves	500mm	TWG50	£285
c/w Sirius LED Lights & Glass Shelves	500mm	TWG50SIR	£354
c/w Halo LED Downlights	500mm	TWG50LED	£385
c/w Edge Lit Shelves	500mm	TWG50LSH	£393
Aluminium Frame with Reflective Glass			
c/w Reflective Glass & MFC Shelves	500mm	TWG50RFL	£263
c/w Reflective Glass & Sirius LED Downlights	500mm	TWG50RFLSIR	£315
c/w Reflective Glass & Halo LED Downlights	500mm	TWG50RFLLED	£349
c/w Reflective Glass & Edge Lit Shelves	500mm	TWG50RFLSH	£356

These glazed wall units are supplied with glass shelves



DRESSER HEIGHT GLAZED WALL UNITS (1207mm)

Dresser Height Glazed Unit

Range Specific Frames with Clear Glass			
Standard Dresser Glazed Unit & MFC Shelves	500mm	DR50	£341
c/w Sirius LED Lights & Glass Shelves	500mm	DR50SIR	£441
c/w Halo LED Downlights	500mm	DR50LED	£469
c/w Edge Lit Shelves	500mm	DR50LSH	£539

These glazed wall units are supplied with glass shelves

Please refer to page 62 for illustrations of range specific glazed doors

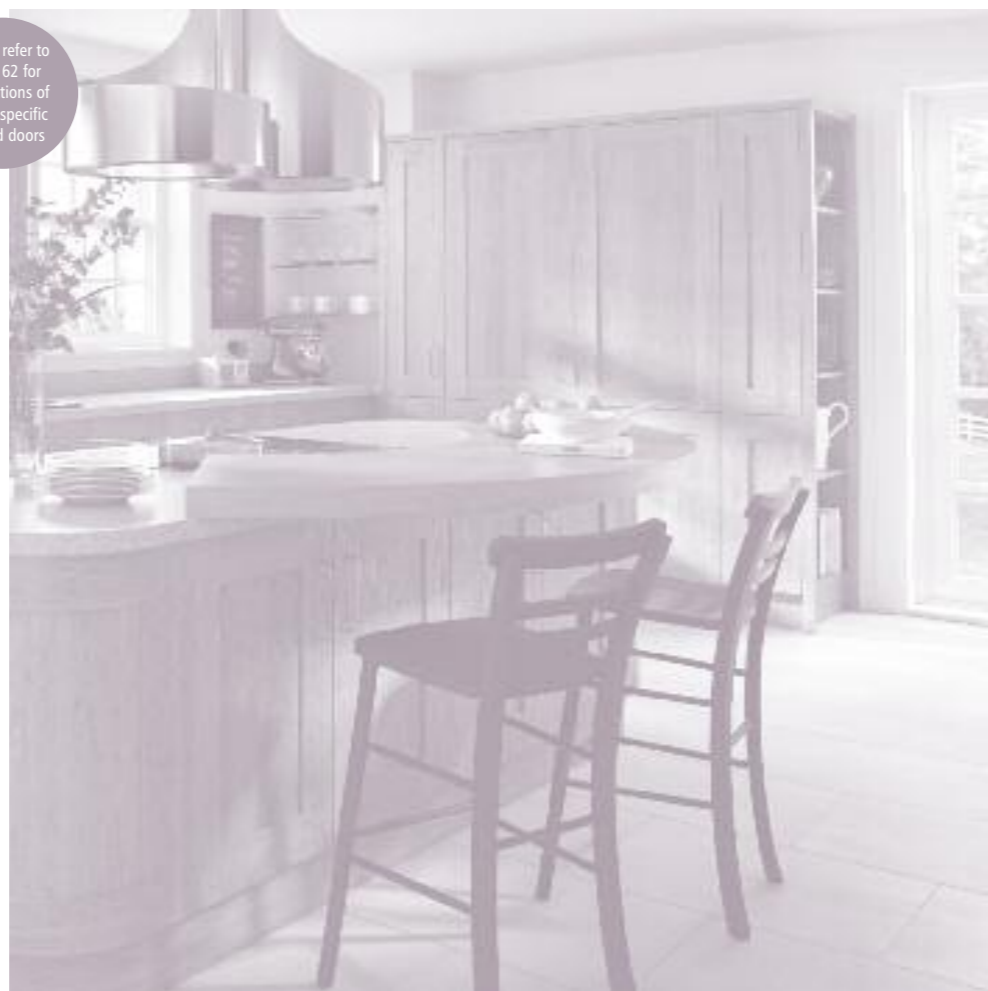

Open Unit Wine Rack

500/720/300mm	Standard
WOP50	£114
150/720/300mm	WRT15
	£72
	Tall
150/900/300mm	TWR15
	£80

ACCESSORY BASE/WALL UNITS

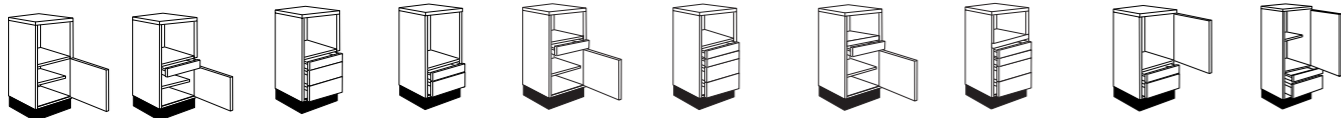

EURO HEIGHT UNITS

Type 1 Single Oven Housing Highline	Type 2 Single Oven Housing Drawerline	Type 3 Single Oven Housing	Type 6 Double Oven Housing	Type 8 Microwave/Steam Oven/coffee Machine Housing	Type 9 Microwave/Steam Oven/coffee Machine Housing	Type 10 Microwave/Steam Oven/coffee Machine Housing	Type 11 Microwave/Steam Oven/coffee Machine Housing	Type 1 Fridge/ Freezer Housing	Type 1 Pantry Unit
600/1492mm EOH60 T1 £314	600/1492mm EOH60 T2 £415 (£472)	c/w 3 Drawers 600/1492mm EOH60 T3 £606 (£814)	c/w 2 Drawers 600/1492mm EOH60 T6 £439 (£571)	EOH60 T8 £433 (£490)	EOH60 T9 £740 (£1,004)	EOH60 T10 £452 (£509)	EOH60 T11 £759 (£1,023)	c/w 2 Drawers 600/1492mm EFH60 T1 £627 (£759)	c/w 2 Drawers 600/1492mm EPH60 T1 £637 (£769)

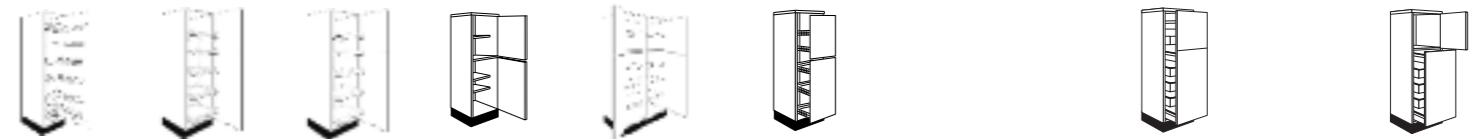

APPLIANCE AND TALL UNITS

Tandem Larder Unit	Tandem Solo Unit	Convoy Premio Unit (illus r/h)	Larder Unit	Double Larder Unit	Larder Unit c/w Pull Out Wirework	Type 1 Pullout Larder Unit	Type 2 Pullout Larder Unit
500/2117mm LUS0TDM £1,397	600/2117mm LUG6SOLO £1,214	600/2117mm (L/H) LUG6CONVL £1,577	300/2117mm LUS30 £548	1000/2117mm LU100 £1,318	With Arena Shelves Standard 300/2117mm LUS30A £1,173	Standard 300/2117mm LUS30P T1 £1,042	Standard 300/2117mm LUS30P T2 £896
Tall 500/2297mm TLUS0TDM £1,428	with Graphite Wirework 600/2117mm LUG6BSOLO £1,341	600/2117mm (R/H) LUG6CONVR £1,577	400/2117mm LU40 £553	Tall 1000/2297mm TLU100 £1,396	With Graphite Wirework Standard 300/2297mm LUS30B £1,297	c/w 3 Pan Drawers, 4 Internal Drawers Standard 300/2117mm LUS30P T1 £1,042	c/w 2 Pan Drawers, 3 Internal Drawers Standard 300/2117mm LUS30P T2 £896
with Graphite Wirework 500/2117mm LUS0BTD £1,544	600/2117mm (L/H) LUG6CONVL £1,742	with Graphite Wirework 600/2117mm (R/H) LUG6CONVR £1,742	500/2117mm LUS50 £557	Tall 500/2297mm TLUS0 £580	400/2117mm LU40A £1,271	400/2117mm LU40P T1 £1,074	500/2117mm LU40P T2 £921
			600/2117mm* LUG60 £610		500/2297mm LUS50A £1,369	500/2117mm LUS50P T1 £1,106	500/2117mm LUS50P T2 £945
			Tall 300/2297mm TLU30 £570		Tall 300/2297mm TLU30A £1,219	Tall 300/2297mm TLU30P T1 £1,064	Tall 300/2297mm TLU30P T2 £918
			400/2297mm TLU40 £575		400/2297mm TLU40A £1,322	400/2297mm TLU40P T1 £1,097	400/2297mm TLU40P T2 £943
			500/2297mm TLUS0 £580		500/2297mm TLU50A £1,425	500/2297mm TLU50P T1 £1,128	500/2297mm TLU50P T2 £967

(Please specify handing of door)

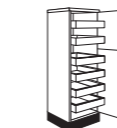

Type 3 Larder Unit

c/w 6 Internal Drawers	
Standard	Tall
300/2117mm LUS30P T3 £1,088 (£1,318)	300/2297mm TLU30P T3 £1,109 (£1,339)
400/2117mm LU40P T3 £1,121 (£1,383)	400/2297mm TLU40P T3 £1,142 (£1,404)
500/2117mm LUS50P T3 £1,153 (£1,439)	500/2297mm TLUS50P T3 £1,175 (£1,461)
600/2117mm LUG60P T3 £1,258 (£1,574)	

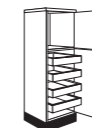

Type 4 Larder Unit

c/w 4 Internal Drawers	
Standard	Tall
300/2117mm LUS30P T4 £896 (£1,050)	300/2297mm TLU30P T4 £918 (£1,071)
400/2117mm LU40P T4 £920 (£1,094)	400/2297mm TLU40P T4 £942 (£1,116)
500/2117mm LUS50P T4 £943 (£1,133)	500/2297mm TLUS50P T4 £964 (£1,155)
600/2117mm LUG60P T4 £1,120 (£1,330)	



Type 1 1000 Corner Larder to Larder

400/2117mm LUC104T1	£812
500/2117mm LUC105T1	£853
600/2117mm LUC106T1	£874
Tall 400/2297mm TLUC104T1	£862
500/2297mm TLUC105T1	£906



Type 2 1000 Corner Larder to Larder with Le-Mans Pull Out Storage

500/2117mm (L/H)		with Graphite Wirework	
LUC105T2L	£2,019	500/2117mm (L/H)	LUCB105T2L £2,231
500/2117mm (R/H)	LUC105T2R £2,019	500/2117mm (R/H)	LUCB105T2R £2,231
600/2117mm (L/H)		600/2117mm (L/H)	
LUC106T2L	£2,120	LUCB106T2L	£2,343
600/2117mm (R/H)	LUC106T2R £2,120	600/2117mm (R/H)	LUCB106T2R £2,343
Tall		Tall	
500/2297mm (L/H)	TLUC105T2L £2,055	500/2297mm (L/H)	TLUCB105T2L £2,271
500/2297mm (R/H)	TLUC105T2R £2,055	500/2297mm (R/H)	TLUCB105T2R £2,271

* Larder to larder units do not include a blanking panel

(Please specify handing of Le Mans)

(Please specify handing)

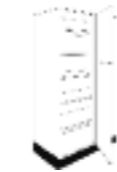

Type 3 1000 Corner Larder to corner

400/2117mm LUC104 T3	£1,176
500/2117mm LUC105 T3	£1,216
600/2117mm LUC106 T3	£1,262
Tall 400/2297mm TLUC104 T3	£1,214
500/2297mm TLUC105 T3	£1,259



Type 4 1000 Corner Larder to corner with Le-Mans Pull Out Storage

500/2117mm (L/H)		with Graphite Wirework	
LUC105 T4L	£2,338	500/2117mm (L/H)	LUCB105 T4L £2,583
500/2117mm (R/H)	LUC105 T4R £2,338	500/2117mm (R/H)	LUCB105 T4R £2,583
600/2117mm (L/H)		600/2117mm (L/H)	
LUC106 T4L	£2,437	LUCB106 T4L	£2,693
600/2117mm (R/H)	LUC106 T4R £2,437	600/2117mm (R/H)	LUCB106 T4R £2,693
Tall		Tall	
500/2297mm (L/H)	TLUC105 T4L £2,373	500/2297mm (L/H)	TLUCB105 T4L £2,622
500/2297mm (R/H)	TLUC105 T4R £2,373	500/2297mm (R/H)	TLUCB105 T4R £2,622

(Please specify handing of Le Mans) (Please specify handing)



1000 Butlers Larder with Wine Racks

1000/2117mm LU100BUT	£1,372
Tall 1000/2297mm TLU100BUT	£1,434

Please note: This unit is only available on Lissa Oak cabinet

BUTLERS LARDER ACCESSORY ITEMS

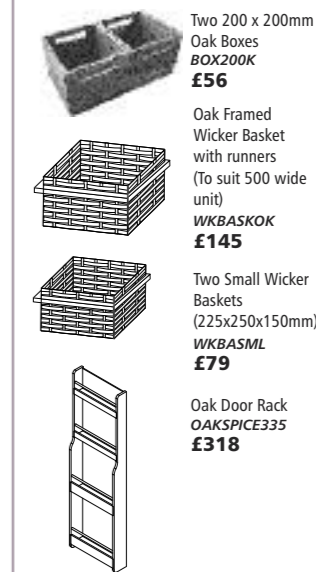

Two 200 x 200mm Oak Boxes
BOX200K
£56

Oak Framed Wicker Basket with runners (To suit 500 wide unit)
WKBASKOK
£145

Two Small Wicker Baskets (225x250x150mm)
WKBASML
£79

Oak Door Rack
OAKSPICE335
£318

APPLIANCE AND TALL UNITS



Built Under Oven Housing	Built Under Oven Housing with drawer	Type 1 Double Oven Housing	Type 2 Double Oven Housing	Type 3 Double Oven Housing	Type 5 Single Oven/Microwave Unit	Type 6 Single Oven Housing	Type 7 Single Oven Housing	Type 8 Single Oven Housing	Type 9 Microwave/Steam Oven/coffee Machine Housing	Type 10 Microwave/Steam Oven/coffee Machine Housing	Type 11 Microwave/Steam Oven/coffee Machine Housing
600mm BUOH £133	600mm BUOHD £213	600/2117mm OH60 T1 £507 600/2117mm OH60 T2 £676 (£825) Tall 600/2297mm TOH60 T1 £524	c/w 2 Drawers 600/2117mm OH60 T2 £676 (£825) Tall 600/2297mm TOH60 T2 £692 (£842)	c/w 3 Drawers 600/2117mm OH60 T3 £776 (£965) Tall 600/2297mm TOH60 T3 £792 (£982)	600/2117mm OH60 T5 £487 600/2297mm TOH60 T5 £524	600/2117mm OH60 T6 £636 (£693) Tall 600/2297mm TOH60 T6 £652 (£709)	600/2117mm OH60 T7 £751 (£865) Tall 600/2297mm TOH60 T7 £767 (£882)	600/2117mm OH60 T8 £943 (£1,207) Tall 600/2297mm TOH60 T8 £959 (£1,224)	600/2117mm OH60 T9 £769 (£884) Tall 600/2297mm TOH60 T9 £786 (£900)	600/2117mm OH60 T10 £674 (£824) Tall 600/2297mm TOH60 T10† £753 (£903)	600/2117mm OH60 T11† £692 (£842) Tall 600/2297mm TOH60 T11 £760 (£910)

† Supplied with Stainless Steel filler

APPLIANCE AND TALL UNITS

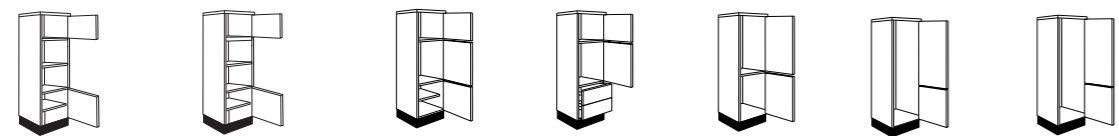

Type 12 Microwave/Steam Oven/coffee Machine Housing	Type 13 Microwave/Steam Oven/coffee Machine Housing	Type 1 Fridge/Freezer Housing	Type 2 Fridge/Freezer Housing	Type 5 Fridge & Freezer Housing	Type 6 Combi Fridge/Freezer Housing	Type 8 Combi Fridge/Freezer Housing
600/2117mm OH60 T12 £505 Tall 600/2297mm TOH60 T12† £587	600/2117mm OH60 T13† £524 Tall 600/2297mm TOH60 T13 £595	600/2117mm FFH60 T1 £703 Tall 600/2297mm TFFH60 T1 £721	c/w 2 Drawers 600/2117mm FFH60 T2 £864 (£1,013) Tall 600/2297mm TFFH60 T2 £880 (£1,030)	600/2117mm FFH60 T5 £639 Tall 600/2297mm TFFH60 T5 £660	600/2117mm FFH60 T6 £604	Tall* 600/2297mm TFFH60 T8 £677

† Supplied with Stainless Steel filler

* Please refer to fascia matrix on page 57 & page 87 for layout of doors.

INTEGRATED APPLIANCE FASCIA

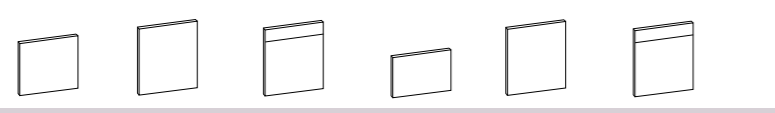

Semi Integrated Dishwasher Fascia	Highline Integrated Fridge/Freezer Fascia	Drawerline Integrated Fridge/Freezer Fascia	Integrated Hood Fascia	Highline Dishwasher Fascia	Drawerline Dishwasher Fascia
600/572mm IFS60 £131	600mm IF60FR £158	600mm IFD60FR £203	600/450mm IF60EXT £121	450mm Slimline IF45 £120 600mm Fully Integrated IF60DW £158	450mm Slimline IFD45 £164 600mm Fully Integrated IFD60DW £203



Accessories

Cornices & Pelnets	Traditional Cornice Wood Veneer (H - 100mm)		Square Section Cornice/Pelmet/Pilaster (H - 36mm)		Traditional Cornice Internal Curve (H - 100mm)	Internal Curved Section - 36mm Square
	1750mm	3600mm	1750mm	3600mm		
Shaker Lissa Oak Wood	TCHVENLAH £102	TCHVENLA £180	CBFVENLAH £69	CBFVENLA £107	TCHCILA £138	CBCILA £77
Shaker Sand Oak Wood	TCHVENSOH £102	TCHVENSO £180	CBVENSOH £69	CBVENSO £107	TCHCISO £138	CBCISO £77
Fusion Shaker Gloss White			CBPAIGWH £46	CBPAIGW £92		

(♦ = Cornice cannot be used on an up and over flap unit)

Cornices & Pelnets	Curved Cornice/Pelmet (H - 36mm) External	Curved Cornice Veneered (H - 100mm) External	938mm Curved Corner Section 50mm Wide	1387mm Curved Corner Section 50mm Wide	100mm Graphite Wide Cornice/Pelmet/Filler 2400 x 100 MFC	Traditional Curved Corner Profile Block (h100)	Corbel
	Shaker Lissa Oak Wood	CBFCVLA £126	TCHCVLA £205	CCSBWLA £56	CCSDTLA £77	TF1GR £30	CCSTCHLA £49
Shaker Sand Oak Wood	CBCVSO £126	TCHCVSO £205	CCSBWSO £56		TF1GR £30		CORSO £109
Fusion Shaker Gloss White	CBVCJGW £126				TF1GR £30		

Plinths	2650mm Plinth (15mm MFC) Supplied with sealing strip	2650mm Plinth (16mm MFC) Aluminium effect	Graphite Plinth with Seal 150 x 2750	2650mm Mirrored Plinth	Curved External Mirrored Plinth	Curved Internal Mirrored Plinth	Plinth Wood Veneer	Plinth Painted
	Shaker Lissa Oak Wood	PLLA £34	PLAL £34	PLGR £34	PLMIR £84	PLCMIR £183	PLCV93MIRT1 £193	PLLAVEN £103
Shaker Sand Oak Wood	PLSO £34	PLAL £34	PLGR £34	PLMIR £84	PLCMIR £183	PLCV93MIRT1 £193	PLSOVEN £103	
Fusion Shaker Gloss White		PLAL £34	PLGR £34	PLMIR £84	PLCMIR £183			PLPAIGW £133

(▲ = Curved Plinth sections go with Veneer/Painted Plinths only. Not for use with MFC Plinths)

Plinths	Curved Plinth Veneered/Lacquered External	Plinth Internal Curved Section	100mm Filler Panels 18mm MFC - 2297mm Edged 1 Long & 2 Short	Filler Panel Aluminium 2400 x 100mm (18mm Thick)	External Corner Post	
					L/Hand	R/Hand
Shaker Lissa Oak Wood	PLCVLA £152	PLCV93LA £66	TF1LA £30	TF1AL £30		
Shaker Sand Oak Wood	PLCVSO £152	PLCV93SO £66	TFMSO £30	TF1AL £30		
Fusion Shaker Gloss White	PLCVPGW £118			TF1AL £30	ECPLHJGW £164	ECPRHJGW £164

(▲ = Curved Plinth sections go with Veneer/Painted Plinths only. Not for use with MFC Plinths)

Panels										
Shaker Lissa Oak Wood	ESP1LA £34	ESP1AL £34	ESP1GR £34	ESP1GR £34	ESPPLKBLA £146	EPPLKWLA £147	EPPLKHLA £375	MPP1LA £88	MPP1AL £111	MPP1GR £111
Shaker Sand Oak Wood	ESPMSO £34	ESP1AL £34	ESP1GR £34	ESP1GR £34	ESPPLKBSO £146	EPPLKWSO £147	EPPLKHSO £375	MPPMSO £88	MPP1AL £111	MPP1GR £111
Fusion Shaker Gloss White	ESP1AL £34	ESP1AL £34	ESP1GR £34	ESP1GR £34	ESPPAIBGW £146	EPPLKWSO £147	EPPLKHSO £375	MPPMSO £88	MPP1AL £111	MPP1GR £111

Panels cont'd								
Shaker Lissa Oak Wood				BBBP1LA £87		BBBP1AL £87	BBBP1GR £87	BBBPPLKLA £468
Shaker Sand Oak Wood				BBBP1LA £87		BBBP1AL £87	BBBP1GR £87	BBBPPLKSO £468
Fusion Shaker Gloss White	DEPIGW £121	EPPAIWGW £147	EPPAIHGW £375	BBBP1LA £87	BBBP1AL £87	BBBP1AL £87	BBBP1GR £87	BBBPPLKSO £468

Items marked 1, 2, 3 & 4 are all reversible panels - planked on one side and plain on the other.

Panels cont'd						
Shaker Lissa Oak Wood	ETLA £17	ETSLA £26	ETAL £17	ETSAL £26	ETGR £17	ETSGR £26
Shaker Sand Oak Wood	ETSO £17	ETSMO £26	ETAL £17	ETSAL £26	ETGR £17	ETSGR £26
Fusion Shaker Gloss White	ETGW £17	ETSGW £26	ETAL £17	ETSAL £26	ETGR £17	ETSGR £26

Decorative Accessories			
	BCFLA £307	PILBLA £170	PILDMLA £207

HIGHLINE BASE UNITS													
150mm BU15H £129	800mm BU80 £414	600mm BEL60 £227	300mm BFRS30 £244	300mm c/w Arena Shelves L/H BFR30LA £493	300mm c/w Arena Shelves R/H BFR30RA £493	300mm B30AW with Graphite Wirework £506	400mm B40WRL £600	150mm BU15 £314	150mm BU15SS £344	400mm B40V £338	300mm B30PT2 £351	300mm B30PT3 £414 (£490)	
300mm BU30 £221	900mm BU90 £420										400mm B40PT2 £363	400mm B40PT3 £428 (£515)	
400mm BU40 £227	1000mm BU100 £420										500mm B50V £358	450mm B45PT2 £370	450mm B45PT3 £438 (£529)
450mm BU45 £231											600mm B60V £409	500mm B50PT2 £374	500mm B50PT3 £443 (£539)
500mm BU50 £231											600mm B60PT2 £426	600mm B60PT3 £497 (£603)	
600mm BU60 £278													

HIGHLINE CORNER BASE UNITS							
900mm L/H c/w 450mm door BCC145ML £994	with Graphite Wirework 900mm L/H c/w 450mm door BCCB145ML £1,098	800mm c/w 400mm door BC80 £348	930/930mm BC93 £610	1000mm c/w 500mm door & Arena Shelves BCC100A £686	900mm L/H c/w Arena Shelves 450mm door BCM145LA £1,292	930/930mm c/w Arena Shelves BCC93A £861	930/930mm BCCU93/SHK £639
1000mm L/H c/w 500mm door BCC100ML £1,028	1000mm L/H c/w 500mm door BCCB100ML £1,136	900mm c/w 450mm door BC90 £354	1030/1030mm BC103 £638	1000mm c/w 600mm door & Arena Shelves BCC120A £699	1000mm L/H c/w Arena Shelves 500mm door BCM100LA £1,304		
1000mm L/H c/w 600mm door BCC160ML £1,096	1000mm L/H c/w 600mm door BCCB160ML £1,211	1000mm c/w 500mm door BC100 £354			1000mm L/H c/w Arena Shelves 600mm door BCM160LA £1,316		
900mm R/H c/w 450mm door BCC145MR £994	900mm R/H c/w 450mm door BCCB145MR £1,098	1000mm c/w 500mm door BC120 £395			900mm R/H c/w Arena Shelves 450mm door BCM145RA £1,292		
1000mm R/H c/w 500mm door BCC100MR £1,028	1000mm R/H c/w 500mm door BCCB100MR £1,136				1000mm R/H c/w Arena Shelves 500mm door BCM100RA £1,304		
1000mm R/H c/w 600mm door BCC160MR £1,096	1000mm R/H c/w 600mm door BCCB160MR £1,211				1000mm R/H c/w Arena Shelves 600mm door BCM160RA £1,316		

* Corner base units do not include a blanking panel. The end support panel ESP can be used for this purpose if required.

DRAWERLINE BASE UNITS											
300mm BD30 £315 (£360)	800mm BD80 £627 (£725)	800mm BSD80 £556 (£605)	300mm BDD30 £258	800mm BDD80 £508	300mm BFRS30D £291	300mm c/w Arena Shelves L/H BFR30DLA £531	300mm BDD30AW £447	400mm BDD40WRR £585	400mm BD40V £413 (£460)	300mm BD30PT1 £469	
400mm BD40 £333 (£382)	900mm BD90 £637 (£739)	900mm BSD90 £564 (£615)	400mm BDD40 £274	900mm BDD90 £514		300mm c/w Arena Shelves R/H BFR30DRA £531 (illus r/h)	with Graphite Wirework 400mm BDD40WRL £585	400mm BD50V £436 (£485)	500mm BD50V £484 (£537)	400mm BD40PT1 £493	
450mm BD45 £339 (£390)	1000mm BD100 £641 (£745)	1000mm BSD100 £566 (£618)	450mm BDD45 £278	1000mm BDD100 £514			300mm BDD30BW £494	600mm BD60V £503		450mm BD45PT1 £503	
500mm BD50 £341 (£393)			500mm BDD50 £278							500mm BD50PT1 £510	
600mm BD60 £388 (£445)			600mm BDD60 £325							600mm BD60PT1 £565	

DRAWERLINE CORNER BASE UNITS						
800mm c/w 400mm door BCD80 £448 (£497)	930/930mm BCD93 £685	1000mm c/w 500mm door & Arena Shelves BCCD10A £686 (£735)	900mm L/H c/w 450mm door & Arena Shelves BCMD14LA £1,404 (£1,452)	1000mm L/H c/w 500mm door & Arena Shelves BCMD16LA £1,433 (£1,487)	930/930mm c/w Arena Shelves BCCD93A £836	900mm L/H c/w 450mm door BCCD14ML £1,007 (£1,055)
900mm c/w 450mm door BCD90 £456 (£507)	1030/1030mm BCD103 £699	1000mm c/w 600mm door & Arena Shelves BCCD12A £699 (£753)	1000mm L/H c/w 500mm door & Arena Shelves BCMD10LA £1,418 (£1,467)	1000mm L/H c/w 600mm door & Arena Shelves BCMD16RA £1,433 (£1,487)		900mm R/H c/w 450mm door BCCD14MR £1,007 (£1,055)
1000mm c/w 500mm door BCD100 £458 (£510)			1000mm R/H c/w 450mm door & Arena Shelves BCMD14RA £1,404 (£1,452)	1000mm R/H c/w 500mm door & Arena Shelves BCMD10RA £1,418 (£1,467)		1000mm L/H c/w 600mm door BCCD10ML £1,039 (£1,089)
1000mm c/w 600mm door BCD120 £499 (£556)						1000mm R/H c/w 600mm door BCCD10MR £1,039 (£1,089)
						1000mm L/H c/w 500mm door BCCD16ML £1,102 (£1,156)
						1000mm R/H c/w 500mm door BCCD16MR £1,102 (£1,156)

* Corner base units do not include a blanking panel. The end support panel ESP can be used for this purpose if required.



DRAWER PACK UNITS

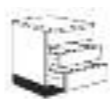
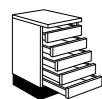

5 Drawer Pack		4 Pan Drawer Pack		3 Pan Drawer Pack		2 Drawer Unit		2 Drawer Unit c/w Internal Drawer		Base with 1 Drawer and 2 Wicker Baskets		Sink Pan Drawer Unit 1 Dummy drawer 1 Cut out drawer option	
300mm DP30	£656 (£877)	500mm PD50/4	£652 (£878)	500mm PD50/3	£556 (£747)	600mm PD60/2	£462 (£612)	600mm PDT60/2	£565	500mm WB50	£345 (£394)	900mm PDS90/3	£763
400mm DP40	£724 (£970)	600mm PD60/4	£697 (£943)	600mm PD60/3	£591 (£798)	800mm PD80/2	£534 (£713)	800mm PDT80/2	£647	Oak option		2 Cut out drawer option	
450mm DP45	£738 (£992)	800mm PD80/4	£917 (£1,198)	800mm PD80/3	£774 (£1,017)	900mm PD90/2	£590 (£751)	900mm PDT90/2	£706	500mm	£504 (£553)	900mm	£774
500mm DP50	£748 (£1,010)	900mm PD90/4	£952 (£1,236)	900mm PD90/3	£838 (£1,067)	1000mm PD100/2	£629 (£792)	1000mm PDT100/2	£751				
600mm DP60	£802 (£1,089)	1000mm PD100/4	£1,025 (£1,317)	1000mm PD100/3	£901 (£1,134)								
800mm DP80	£1,061 (£1,379)												
900mm DP90	£1,067 (£1,405)												
1000mm DP100	£1,149 (£1,500)												

CURVED END BASE UNIT



Curved End Base Unit	Single Base Unit
300mm c/w 1 door & 1 shelf CEB301 £528	260mm Base Unit BU26 £166

Please refer to special worktop planning guidelines on page 78.



STANDARD & TALL WALL UNITS

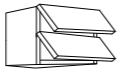
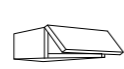
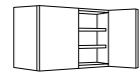
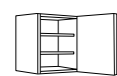

Single Wall Unit		Double Wall Unit		Dresser Unit with Solid Door	Wall Bridging Unit	Double Wall Bridging Unit	Microwave Unit	Up & Over Flap Unit	Bi-Fold Wall Bridging Unit
Standard	Tall	Standard	Tall	500/1207mm DR50/SL £269	600/288mm WBG60 £213	600/576mm WDBG60 £395	600/720mm WU60/MW £354	500/720mm WU50/VR £377	600/720mm WBF60 £547
150/720mm WU15 £163	300/900mm TWU30 £223	600/720mm (c/w 2 doors) WU60/2 £359	600/900mm (c/w 2 doors) TWU60/2 £380	600/720mm WU80 £431	900/288mm WBG90 £305	900/576mm WDBG90 £526	600/720mm WU60/VR £424	800/720mm WBF80 £636	900/720mm WBF90 £659
400/720mm WU40 £214	400/900mm TWU40 £230	800/720mm WU80 £431	800/900mm TWU80 £456	900/720mm WU90 £439					
450/720mm WU45 £221	450/900mm TWU45 £236	900/720mm WU90 £439	900/900mm TWU90 £464	1000/720mm WU100 £448					
500/720mm WU50 £225	500/900mm TWU50 £240								
600/720mm WU60 £271	600/900mm TWU60 £323								

Note: 190mm height clearance required.
Do not use in corner with WC60.

See page 54 for details of which cornice cannot be used with this unit

CORNER WALL UNITS



L Shaped Corner Wall Unit	Standard Corner Wall Unit
Standard 630/630/720mm WCL630 £541	WC60 £335
Tall 630/630/900mm TWCL630 £608	

CURVED WALL END UNIT

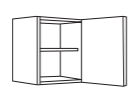

260mm Wall Unit	Curved End Wall Unit	L Curved Internal Wall Unit
260/720mm c/w 1 door & 1 adjustable shelf WU26 £172	300/300mm c/w 1 door & 1 adjustable shelf CEW301 £545	670/670mm c/w 1 door & 2 adjustable shelves WCCU671/SHK £591
	300/300mm c/w 1 door & 1 adjustable shelf TCEW301 £701 only available in Shaker Wood Painted	Only on Matt Ivory, Lissa Oak, Sand Oak, Cashmere (Matt & Gloss) or Platinum White cabinets Please refer to special planning guidelines on page 78.

STANDARD HEIGHT GLAZED WALL UNITS (720mm)



Standard Height Glazed Wall Unit

Range Specific Frames with Clear Glass		Standard Glass Unit & MFC Shelves		500mm		500mm	
c/w Sirius LED Lights & Glass Shelves	400mm	WG40	£269	WG50	£283	c/w Sirius LED Lights & Glass Shelves	500mm
c/w Halo LED Downlights	400mm	WG40SIR	£339	WG50SIR	£356	c/w Halo LED Downlights	500mm
c/w Edge Lit Shelves	-	WG40LED	£373	WG50LED	£389	c/w Edge Lit Shelves	500mm
Aluminium Frame with Reflective Glass		400mm		500mm		500mm	
c/w Reflective Glass & MFC Shelves	400mm	WG40RFL	£216	WG50RFL	£238	c/w Reflective Glass & MFC Shelves	500mm
c/w Reflective Glass & Sirius LED Downlights	400mm	WG40RFLSIR	£273	WG50RFLSIR	£297	c/w Reflective Glass & Sirius LED Downlights	500mm
c/w Reflective Glass & Halo LED Downlights	400mm	WG40RFLLED	£300	WG50RFLLED	£324	c/w Reflective Glass & Halo LED Downlights	500mm
c/w Reflective Glass & Edge Lit Shelves	-			WG50RFLLSH	£331	c/w Reflective Glass & Edge Lit Shelves	500mm

These glazed wall units are supplied with glass shelves

DRESSER HEIGHT GLAZED WALL UNITS (1207mm)



Dresser Height Glazed Unit

Range Specific Frames with Clear Glass		Standard Dresser Glazed Unit & MFC Shelves		500mm		500mm	
c/w Sirius LED Lights & Glass Shelves	500mm	DR50	£361	DR50SIR	£467	c/w Halo LED Downlights	500mm
c/w Halo LED Downlights	500mm	DR50LED	£496	DR50LSH	£570	c/w Edge Lit Shelves	500mm

These glazed wall units are supplied with glass shelves

Please refer to page 62 for illustrations of range specific glazed doors

ACCESSORY BASE/WALL UNITS



Open Unit	Wine Rack
500/720/300mm WOP50 £114	Standard 150/720/300mm WR15 £72
	Tall 150/900/300mm TWR15 £80

EURO HEIGHT UNITS

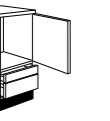
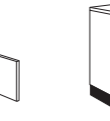
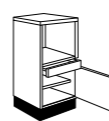
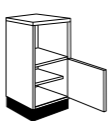

Type 1 Single Oven Housing Highline	Type 2 Single Oven Housing Drawerline	Type 3 Single Oven Housing	Type 6 Double Oven Housing	Type 8 Microwave/Steam Oven/coffee Machine Housing	Type 9 Microwave/Steam Oven/coffee Machine Housing	Type 10 Microwave/Steam Oven/coffee Machine Housing	Type 11 Microwave/Steam Oven/coffee Machine Housing	Type 1 Fridge/Freezer Housing	Type 1 Pantry Unit
600/1492mm EOH60 T1 £332	600/1492mm EOH60 T2 £439 (£496)	c/w 3 Drawers 600/1492mm EOH60 T3 £642 (£849)	c/w 2 Drawers 600/1492mm EOH60 T6 £465 (£597)	EOH60 T8 £458 (£516)	EOH60 T9 £783 (£1,048)	EOH60 T10 £478 (£535) Supplied with Stainless Steel filler	EOH60 T11 £803 (£1,067) Supplied with Stainless Steel filler	c/w 2 Drawers 600/1492mm EFH60 T1 £664 (£796)	c/w 2 Drawers 600/1492mm EP60 T1 £674 (£806)

(Price shown in brackets denotes full unit price with oak drawers)

Tandem Larder Unit	Tandem Solo Unit	Convoy Premio Unit <i>(illus r/h)</i>	Larder Unit	Double Larder Unit	Larder Unit c/w Pull Out Wirework	Type 1 Pullout Larder Unit	Type 2 Pullout Larder Unit
500/2117mm LUS0TDM £1,444	600/2117mm LU60SOLO £1,255	600/2117mm (L/H) LU60CONVL £1,619	300/2117mm LU30 £580	1000/2117mm LU100 £1,363	With Arena Shelves 300/2117mm LU30A £1,242	With Graphite Wirework 300/2117mm LU30P T1 £1,103	c/w 3 Pan Drawers, 4 Internal Drawers 300/2117mm LU30P T2 £948
Tall 500/2297mm TLUS0TDM £1,465	with Graphite Wirework 600/2117mm LU60CONVR £1,619	600/2117mm (R/H) LU60CONVR £1,619	400/2117mm LU40 £585	Tall 1000/2297mm TLU100 £1,410	400/2117mm LU40A £1,347	400/2117mm LU40P T1 £1,138	c/w 2 Pan Drawers, 3 Internal Drawers 400/2117mm LU40P T2 £975
with Graphite Wirework 500/2117mm LUS0BTDM £1,596	600/2117mm LU60BSOLO £1,387	with Graphite Wirework 600/2117mm (L/H) LU60BCONVL £1,789	500/2117mm LU50 £590	Tall 500/2297mm TLU50 £656	500/2117mm LU50A £1,449	500/2117mm LU50P T1 £1,171	500/2117mm LU50P T2 £1,000
Tall 500/2297mm TLUS0BTDM £1,619	600/2117mm (R/H) LU60BCONVR £1,789	Tall 300/2297mm TLU30 £604	400/2297mm TLU40 £610	Tall 600/2297mm TLU60 £614	Tall 300/2297mm TLU30A £1,290	Tall 300/2297mm TLU30P T1 £1,126	Tall 300/2297mm TLU30P T2 £971
	(Please specify handing of door)		500/2297mm TLU50 £614		400/2297mm TLU40A £1,400	400/2297mm TLU40P T1 £1,161	400/2297mm TLU40P T2 £998
					500/2297mm TLU50A £1,508	500/2297mm TLU50P T1 £1,194	500/2297mm TLU50P T2 £1,023

Type 3 Larder Unit	Type 4 Larder Unit	Type 1 1000 Corner Larder to Larder	Type 2 1000 Corner Larder to Larder with Le-Mans Pull Out Storage
c/w 6 Internal Drawers	c/w 4 Internal Drawers		with Graphite Wirework
Standard 300/2117mm LU30P T3 £1,151 (£1,381)	Tall 300/2297mm TLU30P T3 £1,174 (£1,404)	400/2117mm LUC104T1 £829	500/2117mm (L/H) LUC105T2L £2,098
400/2117mm LU40P T3 £1,186 (£1,448)	400/2297mm TLU40P T3 £1,209 (£1,471)	500/2117mm (R/H) LUC105T1 £886	500/2117mm (R/H) LUC105T2R £2,098
500/2117mm LU50P T3 £1,220 (£1,506)	500/2297mm TLU50P T3 £1,243 (£1,530)	600/2117mm LUC106T1 £906	600/2117mm (L/H) LUC106T2L £2,200
600/2117mm LU60P T3 £1,264 (£1,579)	600/2117mm LU60P T4 £1,162 (£1,373)	Tall 400/2297mm TLUC104T1 £893	600/2117mm (R/H) LUC106T2R £2,200
		500/2297mm TLUC105T1 £924	Tall 500/2297mm (L/H) TLUC105T2L £2,136
			500/2297mm (R/H) TLUC105T2R £2,136
			(Please specify handing of Le Mans)

* Larder to larder units do not include a blanking panel

Type 3 1000 Corner Larder to Corner	Type 4 1000 Corner Larder to corner with Le-Mans Pull Out Storage	1000 Butlers Larder with Wine Racks
400/2117mm LUC104 T3 £1,210	500/2117mm (L/H) LUC105 T4L £2,558	1000/2117mm LU100BUT £1,410
500/2117mm LUC105 T3 £1,251	500/2117mm (R/H) LUC105 T4R £2,558	1000/2297mm TLU100BUT £1,473
600/2117mm LUC106 T3 £1,295	600/2117mm (L/H) LUC106 T4L £2,659	
Tall 400/2297mm TLUC104 T3 £1,246	600/2117mm (R/H) LUC106 T4R £2,659	
500/2297mm TLUC105 T3 £1,291	Tall 500/2297mm (L/H) TLUC105 T4L £2,595	
	500/2297mm (R/H) TLUC105 T4R £2,595	
	(Please specify handing of Le Mans)	

BUTLERS LARDER ACCESSORY ITEMS

- Two 200 x 200mm Oak Boxes
BOX200K
£56
- Oak Framed Wicker Basket with runners (To suit 500 wide unit)
WKBASKOK
£145
- Two Small Wicker Baskets (225x250x150mm)
WKBASML
£79
- Oak Door Rack
OAKSPICE335
£318

Please note: This unit is only available on Lissa Oak cabinet

Built Under Oven Housing	Built Under Oven Housing with drawer	Type 1 Double Oven Housing	Type 2 Double Oven Housing	Type 3 Double Oven Housing	Type 5 Single Oven/Microwave Unit	Type 6 Single Oven Housing	Type 7 Single Oven Housing	Type 8 Single Oven Housing	Type 9 Microwave/Steam Oven/coffee Machine Housing	Type 10 Microwave/Steam Oven/coffee Machine Housing	Type 11 Microwave/Steam Oven/coffee Machine Housing
600mm BUOH £140	600mm BUOHD £225	600/2117mm OH60 T1 £536	c/w 2 Drawers 600/2117mm OH60 T2 £715 (£865)	c/w 3 Drawers 600/2117mm OH60 T3 £821 (£1,011)	600/2117mm OH60 T5 £516	600/2117mm OH60 T6 £673 (£730)	600/2117mm OH60 T7 £795 (£909)	600/2117mm OH60 T8 £998 (£1,262)	600/2117mm OH60 T9 £814 (£929)	600/2117mm OH60 T10 £713 (£863)	600/2117mm OH60 T11† £733 (£883)
		Tall 600/2297mm TOH60 T1 £555	Tall 600/2297mm TOH60 T2 £733 (£882)	Tall 600/2297mm TOH60 T3 £839 (£1,028)	Tall 600/2297mm TOH60 T5 £555	Tall 600/2297mm TOH60 T6 £690 (£748)	Tall 600/2297mm TOH60 T7 £812 (£927)	Tall 600/2297mm TOH60 T8 £1,015 (1,280)	Tall 600/2297mm TOH60 T9 £832 (£946)	Tall 600/2297mm TOH60 T10† £797 (£947)	Tall 600/2297mm TOH60 T11 £805 (£955)

† Supplied with Stainless Steel filler

Type 12 Microwave/Steam Oven/coffee Machine Housing	Type 13 Microwave/Steam Oven/coffee Machine Housing	Type 1 Fridge/Freezer Housing	Type 2 Fridge/Freezer Housing	Type 5 Fridge & Freezer Housing	Type 6 Combi Fridge/Freezer Housing	Type 8 Combi Fridge/Freezer Housing
600/2117mm OH60 T12 £534	600/2117mm OH60 T13† £555	600/2117mm FFH60 T1 £745	c/w 2 Drawers 600/2117mm FFH60 T2 £914 (£1,064)	600/2117mm FFH60 T5 £676	600/2117mm FFH60 T6 £639	Tall* 600/2297mm TFH60 T8 £717
Tall 600/2297mm TOH60 T12† £622	Tall 600/2297mm TOH60 T13 £630	Tall 600/2297mm TFH60 T1 £763	Tall 600/2297mm TFH60 T2 £932 (£1,081)	Tall 600/2297mm TFH60 T5 £699		

† Supplied with Stainless Steel filler

* Please refer to fascia matrix on page 69 & page 99 for layout of doors.

Semi Integrated Dishwasher Fascia	Highline Integrated Fridge/Freezer Fascia	Drawerline Integrated Fridge/Freezer Fascia	Integrated Hood Fascia	Highline Dishwasher Fascia	Drawerline Dishwasher Fascia
600/572mm IFS60 £139	600mm IF60FR £168	600mm IFD60FR £214	600/450mm IF60EXT £128	450mm Slimline IF45 £127	450mm Slimline IFD45 £174
				600mm Fully Integrated IF60DW £168	600mm Fully Integrated IFD60DW £214

Cornices & Pelmet	Traditional Cornice Painted (H - 100mm)		Square Section Cornice/Pelmet/Pilaster (H - 36mm)		Modern Cornice (H - 42mm)		Internal Curved Section - 36mm Square	Curved Cornice/Pelmet (H - 36mm) External
	1750mm	3600mm	1750mm	3600mm	1750mm	3600mm		
Shaker Wood Painted - all colours*	TCHPNT_H £102	TCHPNT £179	CBPNT_H £69	CBPNT £107	TCMPNT_H £64	TCMPNT £107	CBCIPNT £77	CBCVPNT £125
Heritage Painted - all colours*	TCHPNT_H £102	TCHPNT £179	CBPNT_H £69	CBPNT £107	TCMPNT_H £64	TCMPNT £107	CBCIPNT £77	CBCVPNT £125
Richmond Painted - all colours*	TCHPNT_H £102	TCHPNT £179	CBPNT_H £69	CBPNT £107	TCMPNT_H £64	TCMPNT £107	CBCIPNT £77	CBCVPNT £125
Stately Shaker Painted - all colours*	TCHPNT_H £102	TCHPNT £179	CBPNT_H £69	CBPNT £107	TCMPNT_H £64	TCMPNT £107	CBCIPNT £77	CBCVPNT £125

Cornices & Pelmet cont'd	Traditional Cornice Internal Curve (H - 100mm)	Curved Cornice (H - 100mm) External	Filler Panel Aluminium 2297 x 100mm (18mm Thick)	Filler Panel Painted 2400 x 100mm (22mm Thick)	938mm Curved Corner Section 50mm Wide	1387mm Curved Corner Section 50mm Wide	100mm Graphite Wide Cornice/Pelmet/ Filler 2400 x 100 MFC
	Shaker Wood Painted - all colours*	TCHCIPNT £138	TCHCVPNT £205	TF1AL £30	TFPNT £111	CCSBWPNT £56	CCSDTPNT £77
Heritage Painted - all colours*	TCHCIPNT £138	TCHCVPNT £205	TF1AL £30	TFPNT £111	CCSBWPNT £56	CCSDTPNT £77	TF1GR £30
Richmond Painted - all colours*	TCHCIPNT £138	TCHCVPNT £205	TF1AL £30	TFPNT £111	CCSBWPNT £56	CCSDTPNT £77	TF1GR £30
Stately Shaker Painted - all colours*	TCHCIPNT £138	TCHCVPNT £205	TF1AL £30	TFPNT £111	CCSBWPNT £56	CCSDTPNT £77	TF1GR £30

Cornices & Pelmet cont'd	Traditional Curved Corner Profile Block (h100)	Modern Curved Corner Profile Block (h42)	Traditional Cornice Small Corner Block 90° (h100)	Modern Cornice Small Corner Block 90° (h42)	Corbel
	Shaker Wood Painted - all colours*	CCSTCHPNT £49	CCSTCMPNT £49	TCHCBPNT £77	TCMCBPNT £78
Heritage Painted - all colours*	CCSTCHPNT £49	CCSTCMPNT £49	TCHCBPNT £77	TCMCBPNT £78	CORPNT £109
Richmond Painted - all colours*	CCSTCHPNT £49	CCSTCMPNT £49	TCHCBPNT £77	TCMCBPNT £78	CORPNT £109
Stately Shaker Painted - all colours*	CCSTCHPNT £49	CCSTCMPNT £49	TCHCBPNT £77	TCMCBPNT £78	CORPNT £109

(◆ = Cornice cannot be used on an up and over flap unit)

Plinths	2650mm Plinth (16mm MFC Aluminium effect)	Graphite Plinth with Seal 150 x 2750	3000mm Plinth Painted	3000mm Skirting Painted	2650mm Mirrored Plinth	Curved 2650mm External Mirrored Plinth	Curved 2650mm Internal Mirrored Plinth	Curved Plinth Painted External	Plinth Internal Curved Section
	Shaker Wood Painted - all colours*	PLAL £34	PLGR £34	PLPNT £133	SKIRTPNT £148	PLMIR £84	PLCV93MIRT1 £183	PLCV93MIRT1 £193	PLCVPT £118
Heritage Painted - all colours*	PLAL £34	PLGR £34	PLPNT £133	SKIRTPNT £148	PLMIR £84	PLCV93MIRT1 £183	PLCV93MIRT1 £193	PLCVPT £118	PLCV93PNT £66
Richmond Painted - all colours*	PLAL £34	PLGR £34	PLPNT £133	SKIRTPNT £148	PLMIR £84	PLCV93MIRT1 £183	PLCV93MIRT1 £193	PLCVPT £118	PLCV93PNT £66
Stately Shaker Painted - all colours*	PLAL £34	PLGR £34	PLPNT £133	SKIRTPNT £148	PLMIR £84	PLCV93MIRT1 £183	PLCV93MIRT1 £193	PLCVPT £118	PLCV93PNT £66

(▲ = Curved Plinth sections go with Veneer/Painted Plinths only. Not for use with MFC Plinths)

Panels	End Support Panel 920 x 670 Aluminium	Graphite End Support Panel/Add on Base End Panel 940 x 670 MFC	Planked Add on Base End Panel 890 x 670 Painted	Planked Add on Wall End Panel 1584 x 375 Painted	Planked Add on Housing End Panel 2347 x 670 Painted	Multi Purpose Panel 2347 x 670 Aluminium	Graphite Multi Purpose Panel/Larder Add On End Panel 2400 x 670 MFC	Planked Breakfast Bar Back Panel 890 x 2050 Painted †	Breakfast Bar Back Panel 940 x 2010 Aluminium (Edged 1L, 1S)	Graphite Breakfast Bar Back Panel 940 x 2010 MFC
	Shaker Wood Painted - all colours*	ESP1AL £34	ESP1GR £34	ESPNTB £121	EPPNTW £121	EPPNTH £251	MPP1AL £111	MPP1GR £111	BBBPPNT £352	BBBP1AL £87
Heritage Painted - all colours*	ESP1AL £34	ESP1GR £34	ESPNTB £121	EPPNTW £121	EPPNTH £251	MPP1AL £111	MPP1GR £111	BBBPPNT £352	BBBP1AL £87	BBBP1GR £87
Richmond Painted - all colours*	ESP1AL £34	ESP1GR £34	ESPNTB £121	EPPNTW £121	EPPNTH £251	MPP1AL £111	MPP1GR £111	BBBPPNT £352	BBBP1AL £87	BBBP1GR £87
Stately Shaker Painted - all colours*	ESP1AL £34	ESP1GR £34	ESPNTB £121	EPPNTW £121	EPPNTH £251	MPP1AL £111	MPP1GR £111	BBBPPNT £352	BBBP1AL £87	BBBP1GR £87

Panels	10 Metre Aluminium Edging Tape - Unglued PVC	10 Metre Roll of Graphite Edging Tape	5 Metre Aluminium Edging Tape - Unglued PVC (1.3mm thick)	5 Metre Roll Graphite Edging Tape (1.3mm thick)
	Shaker Wood Painted - all colours*	ETAL £17	ETGR £17	ETSAL £26
Heritage Painted - all colours*	ETAL £17	ETGR £17	ETSAL £26	ETSGR £26
Richmond Painted - all colours*	ETAL £17	ETGR £17	ETSAL £26	ETSGR £26
Stately Shaker Painted - all colours*	ETAL £17	ETGR £17	ETSAL £26	ETSGR £26

Decorative Accessories	Base Corner Pilaster Painted (h920 w100mm)	Square Pilaster Painted (h920 w100mm)	Pilaster (h920 w75mm)	Canopy † 640 x 1105mm - can be cut down to 460 x 850mm
	Shaker Wood Painted - all colours*	BCFPNT £307	PILSQPNT £307	PILBPNT £171
Heritage Painted - all colours*	BCFPNT £307	PILSQPNT £307	PILBPNT £171	CANOPYPNT £651
Richmond Painted - all colours*	BCFPNT £307	PILSQPNT £307	PILBPNT £171	CANOPYPNT £651
Stately Shaker Painted - all colours*	BCFPNT £307	PILSQPNT £307	PILBPNT £171	CANOPYPNT £651

† Can take extractor flange size 380 x 730mm. Please specify colour on your order.



Items marked 1, 2, 3 & 4 are all reversible panels - planked on one side and plain on the other.

† Painted Breakfast Bar is supplied in 2 pieces

* = Use colour code suffix to specify the colour of your accessory - Shaker Wood Painted, Heritage Painted, Richmond Painted & Stately Shaker Painted

(PB) Painted Light Blue (PO) Painted Oyster (PR) Painted Green (PT) Painted White (VW) Painted Ivory (PH) Painted Hickory (PS) Painted Steel Blue (PY) Painted Sage Grey (PL) Painted Light Grey (PE) Painted Cashmere (PX) Painted Oxford Blue (PM) Painted Limestone (PK) Painted Anthracite (PJ) Painted Sandstone



FEATURE MANTEL ARRANGEMENT

To create a feature mantel in your new kitchen you will need:

- Three larder doors (1245 x 296mm)
- One mantel shelf
- Three mantel brackets or 2 corbels

The illustration shows the mantel shelf in position with three larder doors (1245 x 296mm) fitted to the chimney breast. The mantel shelf is supported by a minimum of three mantel brackets or 2 corbels. A cornice can also be added to the mantel shelf if required.

For ranges where a mantel shelf is not available, a multi-purpose MFC or PVC panel should be used instead. These can be cut to size and edged. These are shown on the table below as item 2.1 & 2.2.

Please note: Decorative mantel brackets are not available in all ranges, see below for details.

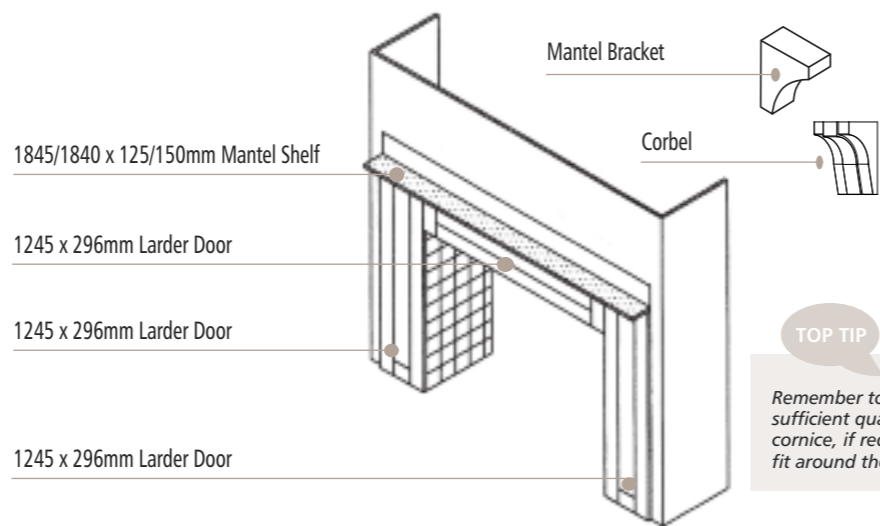

TOP TIP

Remember to order sufficient quantities of cornice, if required, to fit around the mantel.

	Item 1 Larder Door 1245 x 296mm (x3 requ'd)	Item 2 Mantel Shelf 1845 x 125mm (x1 requ'd)	1840 x 150mm (x1 requ'd)	If item 2 is not available use 2.1 & 2.2 instead	Item 2.1 MFC Plinth/Multi Purpose Panel 2650 x 150mm (x1 requ'd)	Item 2.2 Edging Tape 5m (PVC unglued) (x1 requ'd)	Item 3 Mantel Brackets 65 x 90 x 40 (x3 requ'd)	Corbels (x2 requ'd)	If item 3 is not available construct without brackets
Price Group 1									
Grooved Ivory	L30DR £103				MPPMIS £88	ETSMIS £26	MANTELBRIV £38		
Shaker Lissa Oak	L30DR £103				MPP1LA £88	ETSLA £26	MANTELBRFLA £38		
Regent Ivory	L30DR £103				MPPMIS £88	ETSMIS £26	MANTELBRIV £38		
Ivory Prelude	L30DR £103		MANTELSDHV £84				MANTELBRDV £38	CORMAT_ £109	
Shaker Sand Oak	L30DR £103				MPPMSO £88	ETSMO £26		CORSO £109	
Price Group 2									
Shaker Painted (all colours)	L30DR £102	MANTELSH_* £96					MANTELBR_* £38		
Opaco Painted (all colours)	L30DR £102		MANTELSH_* £84				MANTELBR_* £38		
Price Group 3									
Davenport Painted (all colours)	L30DR £167		MANTELSH_* £84				MANTELBR_* £38	CORMAT_ £109	
Classic Painted (all colours)	L30DR £167		MANTELSH_* £84				MANTELBR_* £38	CORMAT_ £109	
Price Group 4									
Shaker Lissa Oak Wood	L30DR £176				MPP1LA £88	ETSLA £26		CORLA £109	
Shaker Sand Oak Wood	L30DR £176				MPPMSO £88	ETSMO £26		CORSO £109	
Price Group 5									
Shaker Wood Painted (all colours)	L30DR £186		MANTELSPNT_* £95				MANTELBRPNT_* £38	CORPNT_ £109	
Richmond Painted (all colours)	L30DR £186		MANTELSPNT_* £95				MANTELBRPNT_* £38	CORPNT_ £109	
Heritage Painted (all colours)	L30DR £186		MANTELSPNT_* £95				MANTELBRPNT_* £38	CORPNT_ £109	
Stately Painted (all colours)	L30DR £186		MANTELSPNT_* £95				MANTELBRPNT_* £38	CORPNT_ £109	

* Use relevant painted colour suffix

* = Use colour code suffix to specify the colour of your accessory

Shaker Wood, Stately Shaker, Richmond & Heritage Painted =
 (PB) Painted Light Blue
 (PD) Primed Wood
 (PO) Painted Oyster
 (PR) Painted Green
 (PT) Painted White
 (VW) Painted Ivory
 (PY) Painted Sage Grey
 (PL) Painted Light Grey
 (PE) Painted Cashmere
 (PH) Painted Hickory
 (PS) Painted Steel Blue
 (PX) Painted Oxford Blue
 (PM) Painted Limestone
 (PK) Painted Anthracite
 (PJ) Painted Sandstone

Shaker Painted =
 (FB) Light Blue Foil
 (FO) Oyster Foil
 (FR) Green Foil
 (FT) White Foil
 (FV) Ivory Foil
 (FY) Sage Grey Foil
 (FL) Light Grey Foil
 (FE) Cashmere Foil
 (FH) Hickory Foil
 (FS) Steel Blue Foil
 (FX) Oxford Blue Foil
 (FM) Limestone Foil
 (FK) Anthracite Foil
 (FJ) Sandstone Foil

Opaco, Davenport & Classic Painted =
 (DB) Painted Light Blue
 (DL) Painted Light Grey
 (DO) Painted Oyster
 (DR) Painted Green
 (DT) Painted White
 (DU) Painted Cashmere
 (DV) Painted Ivory
 (DY) Painted Sage Grey
 (DH) Painted Hickory
 (DS) Painted Steel Blue
 (DX) Painted Oxford Blue
 (DM) Painted Limestone
 (DK) Painted Anthracite
 (DJ) Painted Sandstone

Painted veneered shelf can be used with Shaker Painted

WORKING MANTEL ARRANGEMENT

The items for the working mantel are:

- 2 x 300mm Tall Wall Units
- 2 x Working mantel panels
- 1 x 1245 x 296mm mantel panel
- 1 x mantel shelf
- 3 x mantel brackets or 2 corbels

Working Mantel details - basic dimensions of false chimney breast

Standard Mantel arrangements using a 1245 x 296mm fascia between the mantel blocks require a false chimney breast of 2000mm minimum width and minimum 400mm depth. Two openings of 300mm wide x 900mm high are required to house the working cupboards. The required distance between these openings is 1245mm. The tiled appliance opening width is variable dependent on the dimensions of the width left to the appliance side of the cupboard openings.

Illustration showing the mantel shelf in position with the two working cupboards and square mantel blocks above and a 1245 x 296mm fascia between the mantel blocks.

The mantel shelf is supported by three mantel brackets or 2 corbels.

Cornice can also be fitted to the mantel shelf.

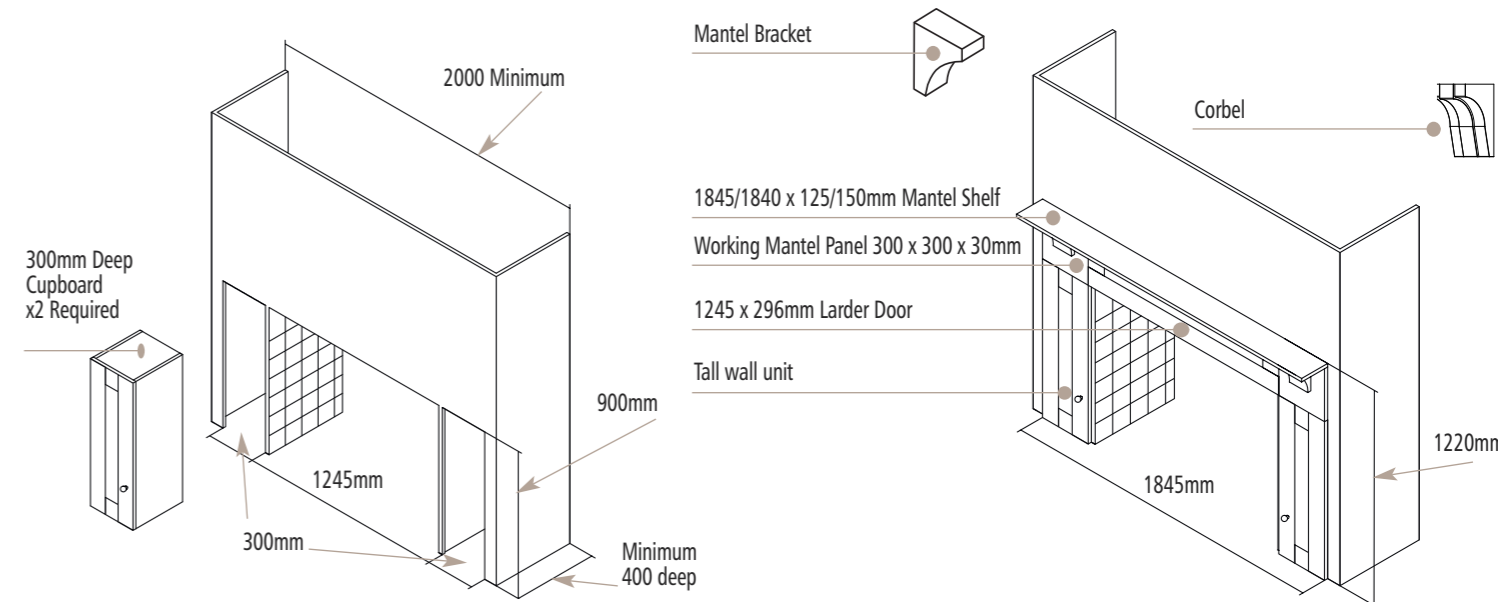

	Item 1 Working Cupboards 300/900mm (x2 requ'd)	Item 2 Working Mantel Panels (x2 requ'd)	If item 2 is not available use 2.1 instead	Item 2.1 Foil End Support Panel	Item 3 Larder Door 1245 x 296mm (x1 requ'd)	Item 4 Mantel Shelf 1845 x 125mm (x1 requ'd)	1840 x 150mm (x1 requ'd)	Item 4.1 If item 4 is not available use 4.1 & 4.2 instead	Item 4.2 MFC Plinth/Multi-purpose Panel (x1 requ'd)	Edging Tape 5m (PVC Unglued) (x1 requ'd)	Item 5 Mantel Brackets (x3 requ'd)	Corbels (x2 requ'd)
Price Group 1												
Shaker Lissa Oak	TWU30 £159			ESP1LA £34	L30DR £103				MPP1LA £88	ETSLA £26	MANTELBRFLA £38	
Ivory Prelude	TWU30 £159	MANTELWPDV £51			L30DR £103	MANTELSDHV £88					MANTELBRDV £38	CORMAT_* £109
Shaker Sand Oak	TWU30 £159			ESPMSO £34	L30DR £103				MPPMSO £88	ETSMO £26		CORSO £109
Price Group 2												
Shaker Painted (all colours)	TWU30 £176			ESPPAIB_ £111	L30DR £102	MANTELSPNT_* £96					MANTELBR_* £38	
Opaco Painted (all colours)	TWU30 £176	MANTELWP_* £51		ESPPAIB_ £111	L30DR £102	MANTELSH_* £84					MANTELBR_* £38	
Price Group 3												
Classic Painted (all colours)	TWU30 £184	MANTELWP_* £51			L30DR £167	MANTELSH_* £84					MANTELBR_* £38	CORMAT_* £109
Classic Painted (all colours)	TWU30 £184	MANTELWP_* £51			L30DR £167	MANTELSH_* £84					MANTELBR_* £38	CORMAT_* £109
Price Group 4												
Shaker Lissa Oak Wood	TWU30 £211	MANTELWPLA £51			L30DR £176				MPP1LA £88	ETSLA £26		CORLA £109
Sand Oak Wood Shaker	TWU30 £211			ESPMSO £34	L30DR £176				MPPMSO £88	ETSMO £26		CORSO £109
Price Group 5												
Shaker Painted Wood (all colours)	TWU30 £223	MANTELWPPNT_* £51			L30DR £186	MANTELSPNT_* £95					MANTELBRPNT_* £38	CORMAT_* £109
Richmond Painted (all colours)	TWU30 £223	MANTELWPPNT_* £51			L30DR £186	MANTELSPNT_* £95					MANTELBRPNT_* £38	CORMAT_* £109
Heritage Painted (all colours)	TWU30 £223	MANTELWPPNT_* £51			L30DR £186	MANTELSPNT_* £95					MANTELBRPNT_* £38	CORMAT_* £109
Stately Painted (all colours)	TWU30 £223	MANTELWPPNT_* £51			L30DR £186	MANTELSPNT_* £95					MANTELBRPNT_* £38	CORMAT_* £109

* Use relevant painted colour suffix



ENGLISH ROSE DRAWER SYSTEMS

TOOL FREE REMOVAL

English Rose understand that once you have your new kitchen in place, you will want to maintain it to the highest standard. English Rose drawers have been designed to allow both the drawer box and drawer fronts to be removed without the need for tools, making the maintenance of your new kitchen much easier. See the instructions below for more details.

METAL DRAWER SYSTEM REMOVAL

To remove the complete drawer box, firstly fully extend the drawer and then simply hold the metal sides and pull the drawer box firmly upwards. It will automatically unclip from the runners.

To re-fit the drawer box, firstly fully extend the drawer runners, position the drawer box onto the runners and push the drawer fully into the cabinet. A click will be heard as the drawer box locks onto the runners.



DRAWER FRONT REMOVAL

To remove the drawer front simply push the two sprung metal levers towards the cabinet and lift the drawer front.

To re-fit the drawer front, engage the clips on the drawer front into the slots on the drawer sides and push the front firmly downwards.



ENGLISH ROSE CURVED CORNER UNITS

When planning with curved corner units, it is important to remember that due to the possibility of handles clashing on adjoining units to adhere to the correct design shown here.



SQUARE SECTION CORNICE/PELMET/PILASTER

PLANNING GUIDELINES

It's the attention to detail that makes our kitchens special. A multi-purpose square section which can be used as a cornice, pelmet or pilaster is available in 36mm on a selection of ranges. See how using this simple addition can be so effective.



Square Section Pilaster

Using the square section pilaster either side of a base unit creates a solid, chunky effect. Simply slot an end panel into the square section.

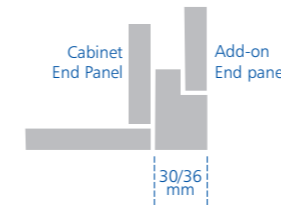

Square Section Flyover

The square section cornice can be used with a flyover shelf to create the appearance of a thicker panel.

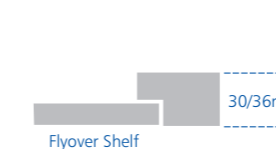

Square Section Cornice/Pelmet

The square section can also be utilised as a cornice or pelmet which frames the cabinet above and below.

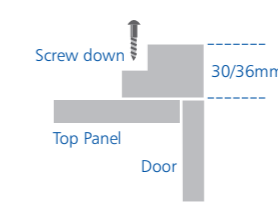

The Square Section Cornice/Pelmet/Pilaster is available in 36mm in the ranges indicated below:

Price Group 1

White Satin
Ivory Shaker
Shaker Lissa Oak
regent Ivory
Ivory Prelude
Shaker Sand Oak
Grooved Ivory
Moda

Price Group 2

Shaker Painted (all colours)
Logica Gloss Ivory
Logica Gloss White
Logica Gloss Stone
Logica Gloss Grey
Logica Gloss Light Grey
Logica Gloss Cashmere
Opaco Painted (all colours)
Abbey

Price Group 3

Fusion Gloss White
Fusion Gloss Grey
Fusion Gloss Light Grey
Fusion Gloss Cashmere
Fusion Gloss Limestone
Fusion Gloss Ivory
Fusion Anthracite
Gloss Stone Shaker
Classic Painted (all colours)
Fusion Painted (all colours)
Concept Painted

Price Group 4

Shaker Lissa Oak Wood
Shaker Sand Oak Wood
Fusion Shaker Gloss White

Price Group 5

Shaker Wood Painted (all colours)
Richmond Painted (all colours)
Heritage Painted (all colours)
Stately Painted (all colours)

PANELS

English Rose wall panels are supplied over sized so you will only need to buy one panel to clad two standard height wall ends.

This applies to all wall panels that are either of the following sizes:

920 x 670mm

1584 x 375mm

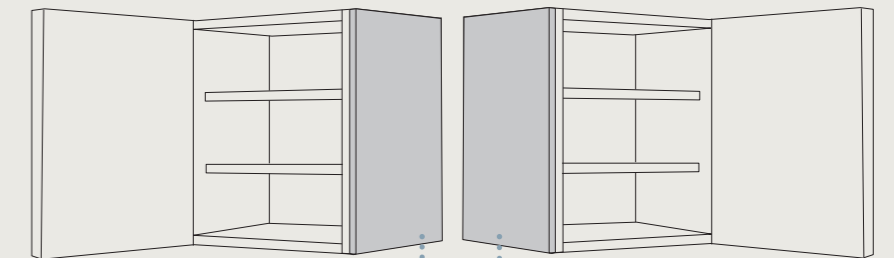

PLEASE NOTE

One wall end panel is all you will need to clad two exposed standard height wall ends.

Allowances need to be made for the cut. Also, when using 36/50mm modern cornice and pelmet, remember to return the cornice and pelmet around the exposed end of the unit to ensure the cut panel will fill the exposed area.



GLAZED DOOR UNITS

English Rose offers a wide variety of glazed units complete with LED downlights, chrome lights, edge lit shelves and reflective glass. Please see the Price Group pages for codes and availability restrictions for some ranges.

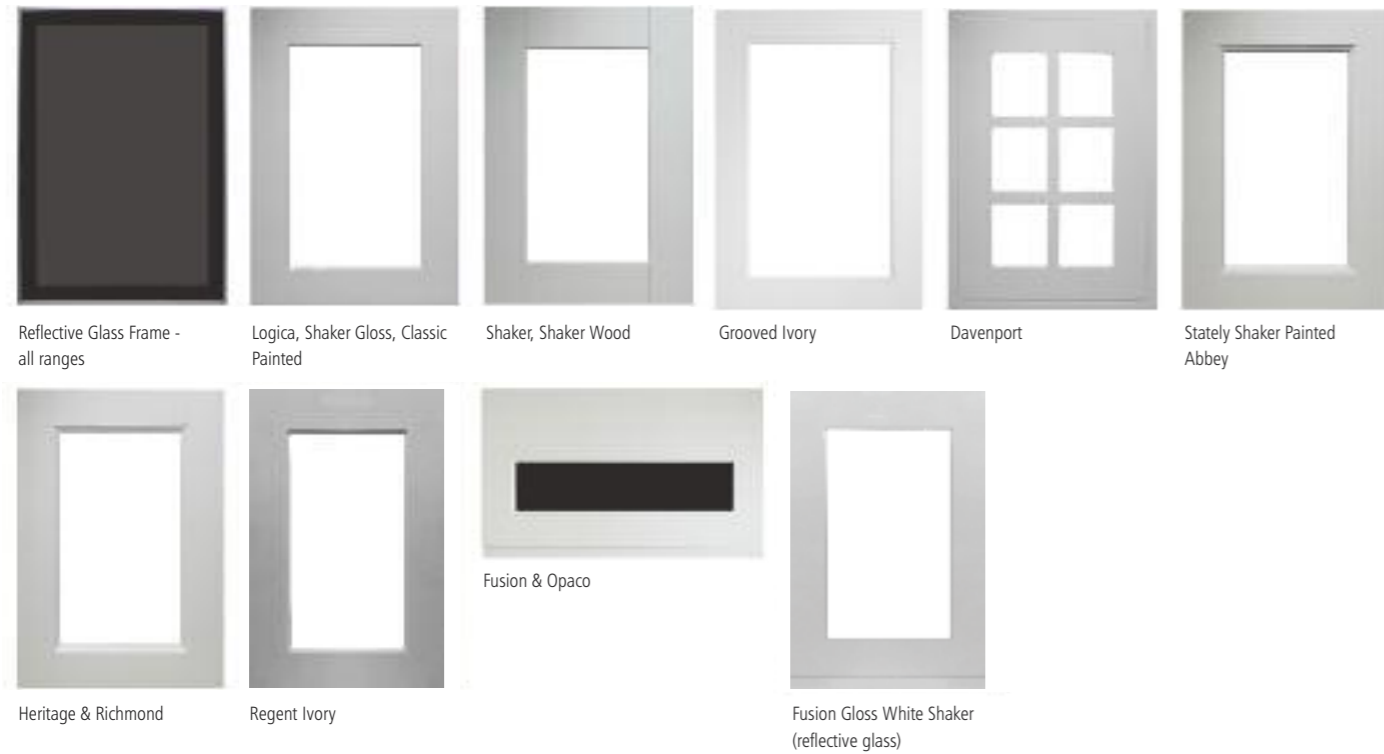

OAK DRAWER DIVIDERS - FOR SOLID OAK DRAWERS

If you have selected the oak drawer option, you can further customise your new English Rose kitchen by selecting oak drawer dividers below, designed specifically for oak drawers. Simply select the divider based on the full width of your drawer, i.e. a CUT60/OAK fits a 600mm wide oak drawer.



919 x 383mm CUTPAN/OAK £153
Supplied ready for a 1000mm pan drawer, can be cut down for smaller drawers. Supplied with 20 posts.

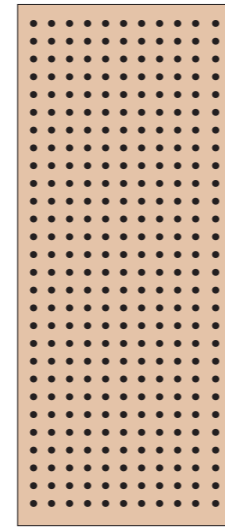

Oak Storage Boxes (For Pan Drawers)

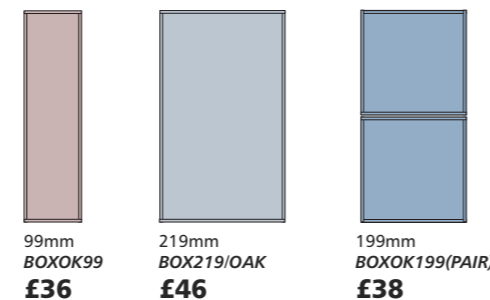

DRAWER DIVIDERS - FOR METAL DRAWERS

If you have selected metal drawers in your new English Rose kitchen you may want to consider drawer dividers to perfectly house your cutlery and utensils. English Rose provides you with a choice of oak inserts for both top drawers and internal drawers.

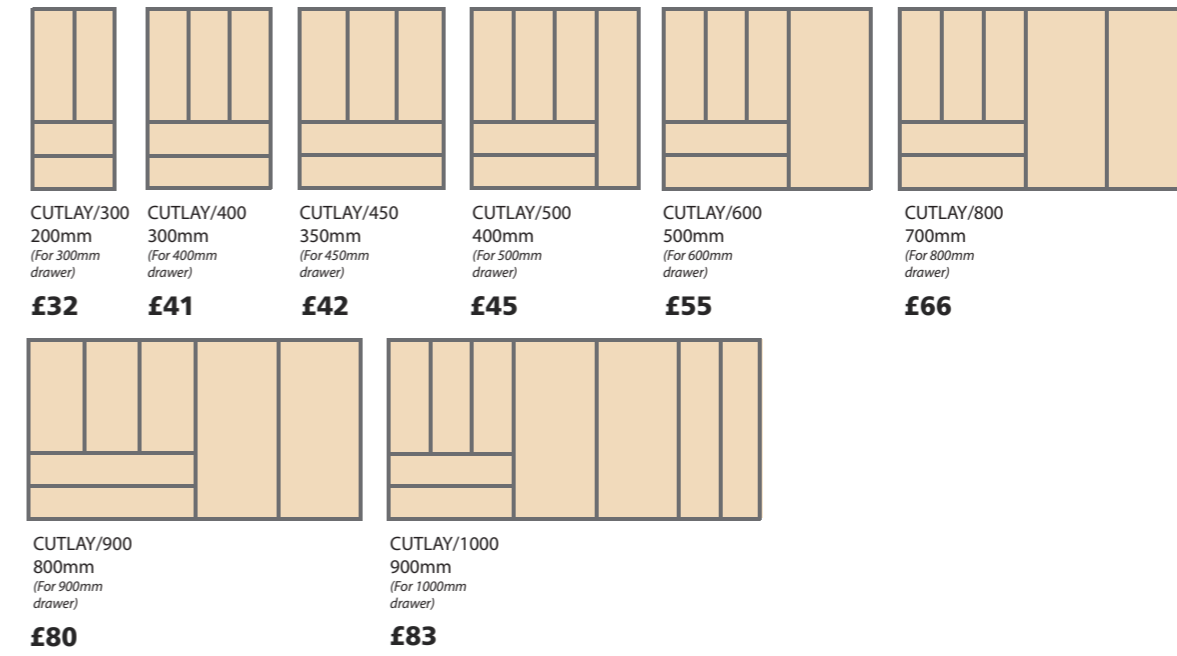

ACCESSORIES

Each of the following drawer accessory modules have been designed to fit inside the drawer dividers. For CUTLAY/600 choose one accessory. For CUTLAY/800, CUTLAY/900 & CUTLAY/1000 choose up to two accessories.

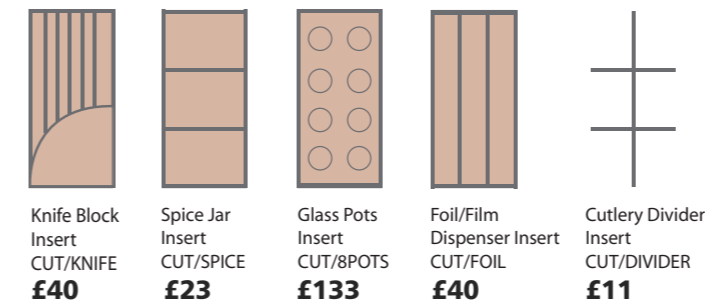

This section demonstrates a selection of the many variants possible using a combination of the five dividers available. Note: The internal size of the drawer is approx 100mm less than the external and needs to be taken into account when ordering dividers.



English Rose also provides storage solutions for your pan drawers. ENGLISH ROSE STORAGE BOXES are available in oak and can provide a practical yet elegant solution for your kitchen sundries.

Storage Boxes

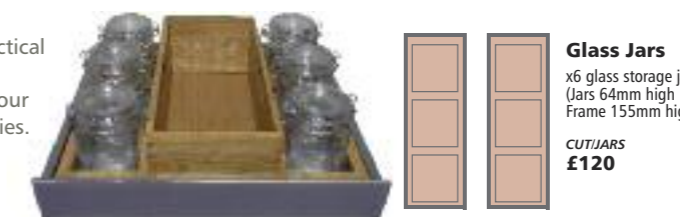
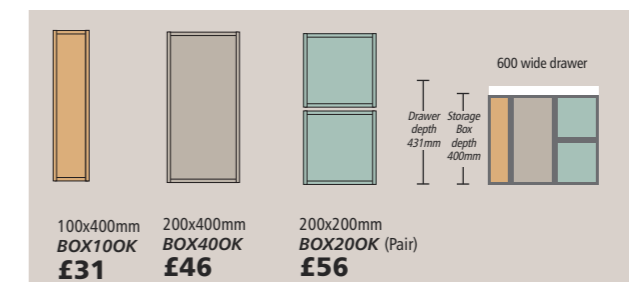

English Rose Peg Boards include a veneered base with moveable posts and can house anything from crockery to pan sets safely and securely.





LIGHTING

Please note: The lights below emit different levels of brightness, use the colour guide to match the same levels

WARM NEUTRAL COOL

All of the lights supplied by English Rose are sold as a kit including the necessary power converters/transformers unless stated otherwise.



3.4w
Polaris surface/recessed round LED 2 light kit
Features COB technology
LTRNDPOL2 £58



3w
2 & 3 Light Halo Kit
LTHAL2 £53
LTHAL3 £77



3w
2 & 3 Light Halo Triangular Lights
LTHALTRI2 £58
LTHALTRI3 £82

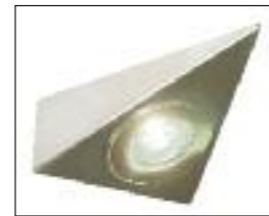

3.4w
Polaris tri-light 2 light kit
Features COB technology
LTRIPOL2 £64



1w
Plinth Light Kit – 4 lights – In situ
LTMONZA4 £68



5.5w
Mains voltage diffused 60 point LED Tri-Lite
LTTRI60 £41



5.5w
Main voltage diffused 60 point round LED light
LTRND60 £41

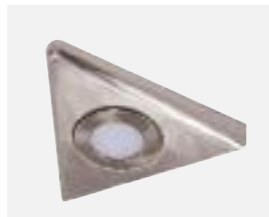

2.6w
Sirius diffused LED Tri Light Sets of 2 & 3
LTSIRTRI2 £48
LTSIRTRI3 £72



2.5w
Grace High Output LED Over/Under Cupboard Light
2.5W x2 Lights incl driver
LTGRACE2 £74
x3 Lights incl driver
LTGRACE3 £107

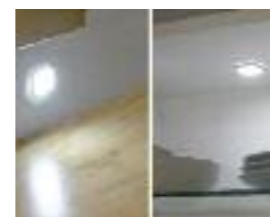

1.5w
Sirius 35mm square plinth/cabinet 3 light kit. Lights are surface mounted using adhesive backing.
LTPL35SQ3 £42



1w
Sirius 32mm round plinth/cabinet 4 light kit
LTPLRND4 £71



Diffused floating shelf - 600mm 10w
LTSHELF60 £138
Diffused floating shelf - 900mm 15w
LTSHELF90 £198



2.6w
Sirius 2 Light LED under unit light kit – in situ
LTSIRIUS2 £48



2.5w
Arezzo High Output LED Surface/Under Cupboard Light
2.5W x2 Lights
LTAREZ2 £89
x3 Lights
LTAREZ3 £130



0.8w strip
2 LED Light Strips to create Edge Lit Glass Shelf Effect in display units
2 x 450mm
LTSHLED2 £64



Pop-Up Socket
With x2 USB Charging Points
(Cut out is 102-105mm)
LTSKTBL (BLACK) £72
LTSKTSL (SILVER) £72



6w
100mm Square flat panel LED 2 light kit
LTSQ100 £53



3w
LED diffused strip light - 222mm
LTLED222 £19
4w
LED diffused strip light - 343mm
LTLED343 £23



8.4w
LED diffused strip light - 526mm
LTLED526 £39
12w
LED diffused strip light - 904mm
LTLED904 £44



4.8w
2m Flexible White LED strip lights.
LTFLXLED/2 £113



LED Drawer lights available in 5 lengths.
LTDRW50 3.5w £58
LTDRW60 4w £64
LTDRW80 5.5w £75
LTDRW900 6w £79
LTDRW100 7w £85



9.2w per 1m length
2m High Output flexible strip light.
LTFLXHP £83



5w
Square slimline LED Under cupboard light.
LTSOLSQ2 £65
LTSOLSQ3 £95



5w
Sirius Tablet style LED under cabinet light.
LTTAB2 £103
LTTAB3 £152



10w per 1m length
3m Solid white bendable LED strip light.
LTBND3 £245
LTBNDCOVER £13



3w
Interior sensor light with integral red sensor.
LTSENC2 £46
LTSENC3 £65



2.6w
Capella mains LED surface/recessed downlight.
LTCAPELLA £25



5w
Solaris LED rectangular slimline under cabinet light
LTSOLRC2 £68
LTSOLRC3 £98



2.6w
Capella mains triangular under cabinet light
LTCAPELTRI £29



Sirius single infra red door switch
LTDRSWITCH £32



Touch dimmer switch
LTDIM £18



Swipe sensor infra red switch
LTIRSWITCH £24

Four Zone Remote Control System

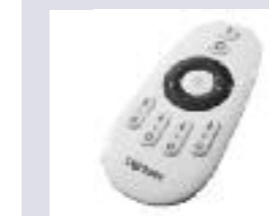
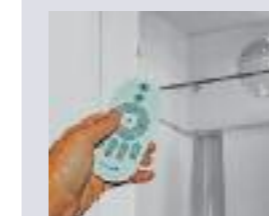

Remote control for up to 4 zones - fits between driver & lights.
On/off & dimming capability - controls a maximum of 144w across 4 zones (max of 72w on any zone)
LTREMO £19



WiFi module 'App' controller
Use instead of LTREMO - app can be downloaded to tablet or phone
LTAPP £64

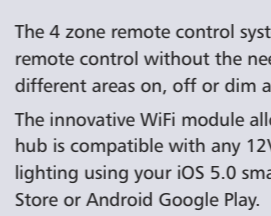

20w driver
Optional - can control up to 20w of lights as one zone
LTDRIVEUP £25

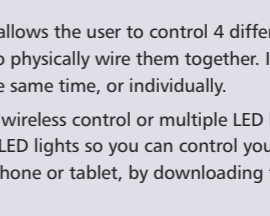



One zone receiver - fits between driver & lights
LTREC £39

2m extension cable
LTEXT2 £3

For full instructions of the Four Zone Remote System & WiFi box view the online tutorial on www.erkitchens.co.uk



CHROME/WIREWORK

 <p>1000mm Chrome Wine Rack Shelf WRS100 £86</p>	 <p>Drip Tray/Protector for 500 Base Unit DRIP50 £13</p>	 <p>Drip Tray/Protector for 900 Base Unit DRIP90 £23</p>	 <p>Linear Mosaic Midway System Set includes 2x 600mm rails, shelf, pot (with quiver), 2x utensil hooks and 1x kitchen roll holder MIDWSET £236</p>	 <p>300 Pull Out Base Graphite Cooking Agent POB30CKNX £212</p>	 <p>iMove Twin Shelf 600 Graphite (Not suitable for bi-fold units) IMOVE60NX £256</p>
--	---	---	--	---	--

PRACTICAL

 <p>Towel Rail - Silver Anodised (Side/top mounting) 465mm TRAIL £55</p>	 <p>Glass Wall Unit Shelves (Pair) For use with Glass Wall Unit (WGS0) which requires 2 shelves and Glass Dresser Unit (DR50) which requires 3 shelves R80005 £37</p>	 <p>Glass Wall Unit Shelves (Pair & Clips) 400mm GLASSPR40 £29</p>	 <p>Shelf Bracket - For use with MFC panels or glass shelves (4-40mm) We recommend min 8mm toughened glass Matt Nickel SHELFBR £7 Aluminium SHELFBRAL £6</p>	 <p>Hinges (pairs) 120° Hinges HINGE1 £12</p>	 <p>Zero protruding Hinge Set INTHINGE1 £24</p>	 <p>Strapping Plates (Pair) STRAP PL £2</p>	 <p>Worktop/ Breakfast Bar Support Leg 870mm - 60mm diameter. Leg can be adjusted by up to 25mm Chrome BBARLEGCH £43 Stainless Steel BBARLEGSS £43</p>
--	--	---	--	--	---	--	--

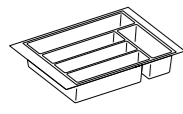
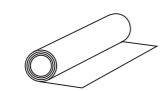
DRAWER ACCESSORIES

 <p>Cutlery Tray Silver 300mm CUT300 £8 600mm CUT600 £24 400mm CUT400 £9 800mm CUT800 £31 450mm CUT450 £10 900mm CUT900 £35 500mm CUT500 £20 1000mm CUT1000 £37</p> <p>Can be trimmed to suit internal metal drawer sizes</p>	 <p>Roll of protective drawer liner 2000 x 500mm LINER £47</p>	 <p>GRASS Pan Drawer Dividers Divider set for 600mm pan drawers PANDIV60 £39 Divider set for 800mm pan drawers PANDIV80 £46 Divider set for 900mm pan drawers PANDIV90 £51 Divider set for 1000mm pan drawers PANDIV100 £55</p> <p>Image shows two sets of dividers</p>
---	---	--

STORAGE

 <p>900mm Pan Drawer Divider Rail (to be cut to size) & 10 no. Clips PDDIV90 £7</p>	 <p>Wicker Basket with runners (To suit 500 wide unit) WKBASKBE £63</p>	 <p>Two Small Wicker Baskets (225x250x150mm) WKBASML £79</p>	 <p>Oak Framed Wicker Basket with runners (To suit 500 wide unit) WKBASKOK £145</p>
---	--	---	--

DAMPERS & LEGS

 <p>Leg Pack - Pack of 4 base unit legs and plinth clips (Black) LEGPACK4 £25</p>

DECORATIVE ACCESSORIES

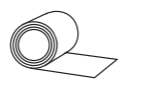
 <p>Stainless Steel Effect Laminate for overlaying MFC 4100 x 150mm wide PLROLLSS £55</p>
--

ENGLISH ROSE WASTE BINS AND RECYCLING SOLUTIONS





Below is a list of the waste management systems, designed to fit into drawer line units, available to you through English Rose.

 <p>1</p>	 <p>2</p>	 <p>3</p>	 <p>4</p>	<p>1 Waste bin sorter - 3 bins WASTEREC: £161 Capacity: 1 x 19 litre, 1 x 12 litre, 1 x 9 litre (40 litre total capacity). Fitting Instructions: Hinged door attached to the bins. For use on 500 minimum width Highline and Drawerline Base Units.</p> <p>2 Combi waste bin 300mm WASTECM: £90 Capacity: 2 x 15 litres Fitting Instructions: Hinged door is not attached to the bin. For use on 300 Base units (not Drawerline).</p> <p>3 Chrome undersink rectangular waste bin WASTEBINSK: £69 (fits in front of plumbing, needs to be fitted in a 450mm base as minimum. Minimum installation size 205d x 450h mm. Capacity: 18 litre Fitting Instructions: Hinged door attached to bin.</p> <p>4 Chrome waste bin with plastic inner bin WASTE: £39 Capacity: 15 litre Fitting Instructions: Hinged door attached to bin. No soft close. For use on 400 Base Units.</p>
 <p>5</p>	 <p>6</p>	 <p>7</p>	 <p>8</p>	<p>5 Waste bin recycler - 3 bins WASTE3+APP: £125 Capacity: 3 x 10 litres. For use on 300 Base Units. (Includes appliance hinge.)</p> <p>6 Waste bin recycler - 2 bins WASTE602 £277 Capacity: 2 x 40 litres. For use on 600 Base Units. (Includes appliance hinge.)</p> <p>7 Waste bin recycler - 4 bins WASTE604 £284 Capacity: 2 x 29 litres, 2 x 28 litres. For use on 600 Base Units. (Includes appliance hinge.)</p> <p>8 Waste bin recycler - 2 bins WASTE502 £267 Capacity: 2 x 40 litres. For use on 500 Base Units. (Includes appliance hinge.)</p> <p>9 Waste bin recycler - 2 bins WASTE452 £267 Capacity: 2 x 29 litres. For use on 450 Base Units. (Includes appliance hinge.)</p> <p>10 Waste bin recycler - 2 bins WASTE402 £238 Capacity: 2 x 29 litres. For use on 400 Base Units. (Includes appliance hinge.)</p>

English Rose Kitchens include great design ideas, not just on the outside but on the inside too.

English Rose storage solutions provide stylish, practical and functional solutions making for better organised and easier access to storage space. In addition to brilliant functionality, English Rose storage solutions stand for exclusive design and a high quality finish. Internal cabinet space is used more efficiently than conventional systems, helping you get the most out of your kitchen.

- 'SoftStopp' soft close action available on pull-out base units and larder units
- Solid bottom shelves available (Arena shelves)
- Greater load bearing capacity than conventional solutions
- Greater level of usable space due to square edges on baskets

 <p>1</p>	 <p>2</p>	 <p>3</p>	 <p>4</p>	 <p>5</p>
--	--	--	--	--

Use the codes shown (after the description below) to locate the price on the Price Group pages

- Larder c/w 5 pull Out Wire Baskets
LU30W, LU30A, LU40W, LU40A, LU50W, LU50A
- Tandem Larder c/w 6 Pairs of Arena Solid Shelves (wire version shown) **LU50TDM**
- Le-Mans Pull Out Storage
BCC145, 100, 160ML/R, BCCD14, 10, 16ML/R
- 150 Base c/w 2 Pull Out Shelves
BU15
- Breakfront unit with Pull Out Wirework
BFR30L/R, BFR30DL/R, BFR30L/RA, BFR30DL/RA

All now available in the **NEW GRAPHITE** finish



HANDLES

Unit prices include the cost of a handle suite. If required, additional handles may be purchased individually at the prices shown. Please specify the Raw Material Code e.g. H0001501.



SUITE 603
Cast Iron Knob
(Two knobs needed for drawer fronts over 300mm and will be charged accordingly.)
H001702 £8



SUITE 667
Lissa Oak Knob
(Two knobs needed for drawer fronts over 300mm and will be charged accordingly.)
H0014600F £8



SUITE 631
Rectangular Pewter knob
16mm centres
H0012701 £8



SUITE 693
Polished Nickel Knob
35mm diameter
H0017800 £8



SUITE 668
Natural Oak Knob
54mm diameter
(Two knobs needed for drawer fronts over 300mm and will be charged accordingly.)
H0016100F £8



SUITE 731
Polished Nickel Ribbed Knob
35mm diameter
H0018900 £8



SUITE 709
Cast Iron Effect Knob
32mm diameter
(Two knobs needed for drawer fronts over 300mm and will be charged accordingly.)
H0005701 £8



SUITE 600
Satin Nickel Finish D & Cup Handle
(D Handle) 96mm centres H0001501 £8
(Cup Handle) 64mm centres H0001502 £8



SUITE 604
Satin Nickel Bar Handle
H0001201 £8



SUITE 602
Nickel Finish Modern D Handle
128mm centres H0001801 £8



SUITE 607
Traditional Straight D Handle
128mm centres H0008700 £8



SUITE 609
Slim Chrome D Handle
160mm centres H0009901 £8



SUITE 611
Curved Brushed Pewter D Handle
128mm centres H0011100 £8



SUITE 617
Chrome Square D Handle
160mm centres H0011300 £8



SUITE 623
Matt Finish Nickel Waisted D Handle
160mm centres H0009100 £8



SUITE 625
Brushed Finish Nickel Heavy D Handle
192mm centres H0009200 £8



SUITE 619
Brushed Nickel Bar handle with Wedge Ends (2 sizes)
160mm centres H0009300 £8
288mm centres H0009301 £8



SUITE 620
Brushed Slim D Handle (2 sizes)
128mm centres H0011700 £8
256mm centres H0011701 £8



SUITE 632
Slim Brushed Rounded D Handle
160mm centres H0012900 £8



SUITE 634
Chrome Wave Handle
160mm centres H0013100 £8



SUITE 638
Satin Finish Square D Handle
160mm centres H0005500 £8



SUITE 640
Brushed Square Waisted D Handle
192mm centres H0014700 £8



SUITE 651
Pewter Sweeping D handle
160mm centres H0015500 £8



SUITE 652
Pewter Pointed Ribbed D Handle
128mm centres H0015600 £8



SUITE 655
160mm Brushed D with Chamfered Edges
H0016300 £8



SUITE 662
Brushed Cup Handle
H0014501 £8
ALSO SUITE 660
KNOB ONLY
Brushed Square Knob
H0014500 £8

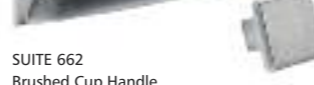

SUITE 663
Brushed Bar Handle with Rings
128mm centres H0014200 £8
192mm centres H0014201 £8



SUITE 664
Brushed Bar Handle with Rings
128mm centres H0014200 £8



SUITE 665
160mm Rounded D Handle
H0014100 £8



SUITE 669
192mm Brushed D with Insert
H0015800 £8



SUITE 673
Boss Modern
192mm centres H0016500 £8



SUITE 674
Round D Chrome/Brushed
160mm centres H0016700 £8



SUITE 677
Traditional Iron ornate D Handle
160mm centres H0016900 £8



SUITE 678
Satin Finish Flat D Handle
160mm centres H0005400 £8



SUITE 682
Cast Iron Flared D Handle
128mm centres H0011900 £8



SUITE 653
Edge Fitted Handle (only for use with "Contact" aluminium profiles)
96mm centres H0015700 £8



SUITE 687
Chrome D Handle with Teardrop Ends
160mm centres H0017400 £8



SUITE 689
Brushed D Handle with Teardrop Ends
160mm centres H0017500 £8



SUITE 692
Cast Iron Slim Smooth D Handle
128mm centres H0017700 £8



SUITE 694
Polished Nickel Knob with 64mm Cup Handle on Drawers
64mm centres CUP H0017801 £8
35mm diameter KNOB H0017800 £8



SUITE 708
Cast Iron Effect D Handle, Cup Handle and Knob
D Handle 98mm centres, Cup 64mm centres
H0005702 £8
H0005701 £8
H0005703 £8



SUITE 711
Brushed Bar handle with Sculptured Feet
160mm centres H0017900 £8



SUITE 713
Brushed Square Bar Curved Under
160mm centres H0018000 £8



SUITE 715
Chrome & White D Handle
160mm centres H0018100 £8



SUITE 719
D Handle with Splayed Feet
128mm centres H0018300 £8



SUITE 721
D Handle with Small Feet
128mm centres H0018400 £8



SUITE 723
Pewter D Handle with Feet
160mm centres H0018500 £8



SUITE 725
Iron Square Waisted D Handle
160mm centres H0018600 £8



SUITE 727
Iron D Handle with Square Feet
128mm centres H0018700 £8



SUITE 729
Polished Pewter Angled D Handle
160mm centres H0018800 £8



SUITE 733
Brushed flat D handle
160mm centres H0019100 £8



SUITE 735
Brushed shaped D handle
160mm centres H0019200 £8



SUITE 737
Edge trim handle
40mm centre H0019300 £8
200mm centre H0019301 £15
350mm centre H0019302 £21



SUITE 738
Edge trim handle
40mm centre H0019300 £8
200mm centre H0019301 £15



SUITE 739
Edge trim handle
40mm centre H0019300 £8



SUITE 742
Thor flared brushed bar handle
128mm centre H0019600 £8



SUITE 744
Concrete effect D handle handle
160mm centre H0019700 £8



SUITE 746
Brushed D handle handle
160mm centre H0019800 £8



SUITE 748
Pronto slim black D handle
160mm centre H0019900 £8



SUITE 750
Pronto slim copper D handle
160mm centre H0020000 £8



SUITE 752
Classic Pewter D handle
160mm centre H0020100 £8



SUITE 754
Welded Steel D handle
160mm centre H0020200 £8



SUITE 757
Polished copper D handle with chamfered edges
160mm centre H0020400 £8



SUITE 759
Edge trim handle
40mm centre H0020500 £8
200mm centre H0020501 £15
350mm centre H0020502 £21



SUITE 760
Edge trim handle
40mm centre H0020500 £8
200mm centre H0020501 £15



SUITE 761
Edge trim handle
40mm centre H0020500 £8



SUITE 762
Edge trim handle
40mm centre H0020600 £8
200mm centre H0020601 £15
350mm centre H0020602 £21



SUITE 760
Edge trim handle
40mm centre H0020600 £8
200mm centre H0020601 £15



SUITE 761
Edge trim handle
40mm centre H0020600 £8



Please turn to page 80 for full details on English Rose 'Contact' Handle-less Kitchens

ENGLISH ROSE SINKS

The English Rose range of sinks and taps has been developed to provide a comprehensive and stylish offer.

Our range of stainless steel sinks are made from 18/10 grade stainless steel - the highest grade available - ensuring your sink is highly resistant to staining, rusting and corrosion.

Along with our range of high quality stainless steel sinks and taps, we also supply granite sinks.

HYDRA

1.0 BOWL SINK

Bowl Size:
480(L) x 430(W) x 200(D)mm
Sink Size:
500(L) x 1000(W) x 200(D) mm
Minimum base unit width:
600mm

Supplied with plumbing kit
Reversible



HMG100MB £272
Colour/Finish: Black



HMG100WH £272
Colour/Finish: White



HMG100GR £272
Colour/Finish: Grey

1.5 BOWL SINK

Bowl Size:
430(L) x 345(W) x 200(D)mm
340(L) x 155(W) x 1460(D)mm
Sink Size:
500(L) x 1000(W) x 200(D)mm
Minimum base unit width:
600mm

Supplied with plumbing kit
Reversible



HMG150MB £294
Colour/Finish: Black



HMG150WH £294
Colour/Finish: White



HMG150GR £294
Colour/Finish: Grey

LIBRA

1.0 BOWL SINK

Bowl Size:
410(L) x 350(W) x 200(D)mm
Sink Size:
500(L) x 800(W) x 200(D)mm
Minimum base unit width:
450mm

Reversible



ET17 £229
Stainless Steel
Plumbing Kit: **SUPLKIT** £17

1.0 BOWL SINK

Bowl Size:
400(L) x 480(W) x 200(D)mm
Sink Size:
500(L) x 1000(W) x 200(D)mm
Minimum base unit width:
600mm

Reversible



ET16 £243
Stainless Steel
Plumbing Kit: **SUPLKIT** £17

1.5 BOWL SINK

Bowl Size:
410(L) x 350(W) x 200(D)mm
300 (L) x 165(W) x 143(D)mm
Sink Size:
500(L) x 1000(W) x 200(D)mm
Minimum base unit width:
600mm

Reversible



ET15 £243
Stainless Steel
Plumbing Kit: **SUPLKIT15** £19

SATURN

1.0 BOWL SINK

Square Undermount
Bowl Size:
400(L) x 500(W) x 200(D)mm
Sink Size:
430(L) x 530(W) x 200(D)mm
Minimum base unit width:
600mm



SQ04 £387
Stainless Steel
Plumbing Kit: **SUPLKIT** £17

1.5 BOWL SINK

Square Undermount
Bowl Size:
400(L) x 340(W) x 200(D)mm
400(L) x 180(W) x 140(D)mm
Sink Size:
430(L) x 580(W) x 200(D)mm
Minimum base unit width:
600mm



SQ07 £579
Stainless Steel
Plumbing Kit: **SUPLKIT15** £19

JUPITER

1.0 BOWL SINK

Classical Undermount

Bowl Size:
400(L) x 480(W) x 195(D)mm
Sink Size:
450(L) x 530(W) x 195(D)mm
Minimum base unit width:
600mm



UM1009 £205
Stainless Steel
Plumbing Kit: **SUPLKIT** £17
(Left hand shown)

1.5 BOWL SINK

Classical Undermount

Bowl Size:
410(L) x 350(W) x 185(D)mm
300(L) x 164(W) x 110(D)mm
Sink Size:
460(L) x 594(W) x 185(D)mm
Minimum base unit width:
600mm



UM0001L (Left hand large bowl) £341
UM0001R (Right hand large bowl) £341
Stainless Steel
Plumbing Kit: **SUPLKIT15** £19
(Left hand shown)

MERCURY

1.0 ROUND BOWL SINK

Bowl Size:
390(L) x 390(W) x 185(D)mm
Sink Size:
440(L) x 440(W) x 185(D)mm
Minimum base unit width:
600mm



1011D/1 £117
Stainless Steel
Plumbing Kit: **SUPLKIT** £17

1.0 ROUND BOWL DRAINER

Bowl Size:
390(L) x 390(W) x 50(D)mm
Sink Size:
440(L) x 440(W) x 50(D)mm
Minimum base unit width:
600mm



1011D/2 £87
Stainless Steel
Plumbing Kit: **SUPLKIT** £17

PLUTO

1.0 BOWL SINK

Bowl Size:
398(L) x 418(W) x 165(D)mm
Sink Size:
600(L) x 965(W) x 165(D)mm
Minimum base unit width:
600mm



EA08 £159
Stainless Steel
Plumbing Kit: **SUPLKIT** £17

Reversible

1.5 BOWL SINK

Bowl Size:
425(L) x 350(W) x 155(D)mm
300(L) x 164(W) x 90(D)mm
Sink Size:
500(L) x 965(W) x 155(D)mm
Minimum base unit width:
600mm



EA09 £208
Stainless Steel
Plumbing Kit: **SUPLKIT15** £19

Reversible

TITAN

1.5 BOWL INSET SINK

Bowl Size:
400(L) x 340(W) x 190(D)mm
300(L) x 160(W) x 145(D)mm
Sink Size:
1000(L) x 500(W) x 210(D)mm
Minimum base unit width:
600mm



EM01LH (Left hand bowl) £342
EM01RH (Right hand bowl) £342
Stainless Steel
Plumbing Kit: **SUPLKIT15** £19
(Left hand shown)

1.0 LARGE BOWL INSET SINK

Bowl Size:
400(L) x 480(W) x 210(D)mm
Sink Size:
1000(L) x 500(W) x 210(D)mm
Minimum base unit width:
600mm



EM02LH (Left hand bowl) £310
EM02RH (Right hand bowl) £310
Stainless Steel
Plumbing Kit: **SUPLKIT** £17
(Left hand shown)

1.0 COMPACT BOWL INSET SINK

Bowl Size:
400(L) x 340(W) x 195(D)mm
Sink Size:
500(L) x 800(W) x 202(D) mm
Minimum base unit width:
450mm



EM03LH (Left hand bowl) £281
EM03RH (Right hand bowl) £281
Stainless Steel
Plumbing Kit: **SUPLKIT** £17
(Left hand shown)

EUROPA

1.5 BOWL INSET DESIGNER SINK

Bowl Size:
400(L) x 340(W) x 185(D)mm
400(L) x 180(W) x 116(D)mm
Sink Size:
1000(L) x 520(W) x 206(D)mm
Minimum base unit width:
600mm



EM05LH (Left hand bowl) £571
EM05RH (Right hand bowl) £571
Stainless Steel
Plumbing Kit: **SUPLKIT15** £19
(Left hand shown)

1.0 LARGE BOWL DESIGNER SINK

Bowl Size:
400(L) x 480(W) x 195(D)mm
Sink Size:
1000(L) x 520(W) x 216(D)mm
Minimum base unit width:
600mm



EM06LH (Left hand bowl) £531
EM06RH (Right hand bowl) £531
Stainless Steel
Plumbing Kit: **SUPLKIT** £17
(Left hand shown)

1.0 COMPACT BOWL DESIGNER SINK

Bowl Size:
400(L) x 340(W) x 185(D)mm
Sink Size:
800(L) x 520(W) x 206(D) mm
Minimum base unit width:
450mm



EM07LH (Left hand bowl) £482
EM07RH (Right hand bowl) £482
Stainless Steel
Plumbing Kit: **SUPLKIT** £17
(Left hand shown)

BELFAST

1.0 BOWL SINK

Bowl Size:
535(L) x 395(W) x 220(D)mm
Sink Size:
600(L) x 455(W) x 250(D)mm
Minimum base unit width:
600mm



CCBL595WH/WK £222

White
Plumbing Kit Supplied

PORTLAND

1.5 BOWL SINK

Bowl Size:
350(L) x 410(W) x 195(D)mm
135(L) x 257(W) x 125(D)mm
Sink Size:
1010(L) x 510(W)
Minimum base unit width: 600mm



CPL10102WH/WK £381

Reversible

White

SUDBURY

2.0 BOWL SINK

Bowl Size:
420(L) x 480(W) x 230(D)mm x2
Sink Size:
900(L) x 555(W) x 250(D)mm
Minimum base unit width:
Bespoke Unit Required
(This may require fillers to accommodate the sink's size variance.)
Please note: This sink will protrude from the front of the base unit



SU20WHHOMESK £542

White

Please note this item is handmade and therefore you need to allow +/- 2% tolerance on these dimensions

1.0 BOWL SINK

Bowl Size:
460(L) x 405(W) x 195(D)mm
Sink Size:
1010(L) x 510(W)
Minimum base unit width: 600mm



CPL10101WH/WK £319

Reversible

White



ELARA
Chrome **HS175 £178**
(0.3 bar pressure)



LEDA
Chrome **HS945 £206**
(0.2 bar pressure)



OBERON
Chrome **HS1075 £215**
(0.2 bar pressure)



CHARON
Chrome **HS935 £183**
(0.2 bar pressure)



VESTA
Chrome **HS105 £80**
(0.3 bar pressure)



COX FOUNTAIN TOWER†
(0.5 Bar Pressure)
Chrome **OPX579 £236**



DAX FLAT
(0.5 Bar Pressure)
Chrome **OPDAXFLAT £422**



DAX SQUARE
(0.5 Bar Pressure)
Chrome **OPDAXSQ £350**



AUKLAND
(0.3 Bar Pressure)
Chrome **OPAUKLAND £205**



LIBERTY
(0.1 Bar Pressure)
Chrome **OPL572 £107**



SWAN*
(0.3 Bar Pressure)
Chrome **OP544 £176**



COX CRUCIFORM**
(0.3 Bar Pressure)
Chrome **OPX545 £157**



VERONA*
(0.3 Bar Pressure)
Chrome **OPJ544 £217**
Brushed Steel **OPSL544 £196**



COX SIDE LEVER**
(0.5 Bar Pressure)
Chrome **OPX572 £196**



SWAN BRIDGE†
(0.3 Bar Pressure, to fit worktop must be recessed on underside)
Chrome **OPL220 £218**



FLEXIO†
(0.5 Bar Pressure)
Chrome **OPX558 £213**



FLEXI SEMI-PROFESSIONAL†
(0.8 Bar Pressure)
Chrome **OPX557 £712**



OVO
(0.5 Bar Pressure)
Chrome **OPOVOTWR £205**



STERLING
(0.3 Bar Pressure)
Chrome **OP545 £98**



CRETA
(0.5 Bar Pressure)
Chrome **OP590 £104**



UNECK SINGLE LEVER
(0.8 Bar Pressure)
Chrome **HS405 £114**



LINEAR TWIN LEVER
(0.8 Bar Pressure)
Chrome **HS965 £203**



ARENA
(0.8 Bar Pressure)
Chrome **OPARENA £264**

† IDEAL FOR MOUNTING ON A SOLID SURFACE SUCH AS TOPP, WOOD OR GRANITE
* NO DIFFUSER SUPPLIED
** REQUIRES A MINIMUM 5 METRE HEAD OR PRESSURED SYSTEM



WORKTOPS & BREAKFAST BARS

DUROPAL

To complete your perfect kitchen we have brought to you the very best selection of worktops from Duropal who are a leading supplier of quality laminate worktops throughout Europe. The Quadra range of worktops are an ideal alternative to solid surface, granite and timber worktops.

Worktops are supplied slightly oversize with separate edge lipping for two ends. They are intended to be cut and edged on site, therefore please make sufficient allowance for this operation. We recommend approximately 50mm.

Please note that English Rose curved worktops are pre-formed specifically to match the radius of the English Rose curved base unit. They may not suit curved base units supplied by other manufacturers.



These high quality, fashionable and durable worktops have achieved the FIRA Gold Award for product excellence are resistant to:

- ✓ Sunlight
- ✓ Spills
- ✓ Scratching
- ✓ Steam
- ✓ Abrasion
- ✓ Cigarette burns
- ✓ Stains



The Quadra profile is designed to provide the appearance of solid surface worktops and the unique 'seal groove' ensures a lifetime of protection against moisture and steam.

PLEASE NOTE

Lead times for all worktops are 8 working days

WORKTOP AVAILABILITY MATRIX

COLOUR	Ref.	Finish		Curved & Straight Edged Polypropylene		Quadra		Laminated Backboard & Upstands 13mm thick	22mm & 40mm Gable Ends (edged in 1.5mm Polypropylene)	Top Seal Code	Top Seal Colour
		Matt	Semi Matt/ Textured	22mm	40mm	40mm	20mm				
Black Brazil	BB	•		•	•	•		•		TS20009	Black Granite
Cosmic Granite	CG		•	•	•	•		•		TS20009	Black Granite
Woodmix Block	WM	•		•	•	•		•	•	TS20009	Black Granite
Slate	SL	•		•	•	•		•	•	TS20007	Dark Grey
Glacial Storm	GS	•		•	•	•		•	•	TS20011	Soft White
Oak Block	AK	•		•	•	•		•	•	TS20014	Oak Woodmix
Harvard Oak	AB	•		•	•	•		•	•	TS20008	Slate
Astral Quartz	AQ	•		•	•	•		•	•	TS20009	Black Granite
Taurus Sand	TD		•	•	•	•		•	•	TS20002	Cream
Block Walnut	BW	•		•	•	•		•	•	TS20003	Oak
Antique Messina	AM		•	•	•	•		•	•	TS20004	Dark Oak
Dark Mountain Oak	DM	•		•	•	•		•	•	TS20007	Dark Grey
Clay Sangha Wenge	SW	•		•	•	•		•	•	TS20012	Stone
Jura Marble	JM	•		•	•	•		•	•	TS20002	Cream
Chapel Oak	CO	•		•	•	•		•	•	TS20004	Dark Oak
Grey Ottowa	GT	•		•	•	•		•	•	TS20011	Soft White
Ipanema White	IW		•	•	•	•		•	•	TS20002	Cream
Ipanema Grey	IG		•	•	•	•		•	•	TS20007	Dark Grey
Platon	PL		•	•	•	•		•	•	TS20004	Dark Oak
Ponderosa Pine	PP	•		•	•	•		•	•	TS20012	Stone
Rabac	RB	•		•	•	•		•	•	TS20008	Slate
Sonoma Oak	SK	•		•	•	•		•	•	TS20013	Light Oak
Marmor Bianco	MA	•		•	•	•	•	•	•	TS20011	Soft White
Tivoli	TV		•	•	•	•		•	•	TS20009	Black Granite
Travertine Stone	TR	•		•	•	•		•	•	TS20013	Light Oak
Bellato Grey	BY		•	•	•	•	•	•	•	TS20011	Soft White
Nero Portoro	NP		•	•	•	•	•	•	•	TS20009	Black Granite
Breccia Paradiso	BP		•	•	•	•	•	•	•	TS20004	Dark Oak
Light Cortona	LC	•		•	•	•		•	•	TS20011	Soft White
Natural Coppice Oak	CP		•	•	•	•		•	•	TS20013	Light Oak

WORKTOP COLOURS

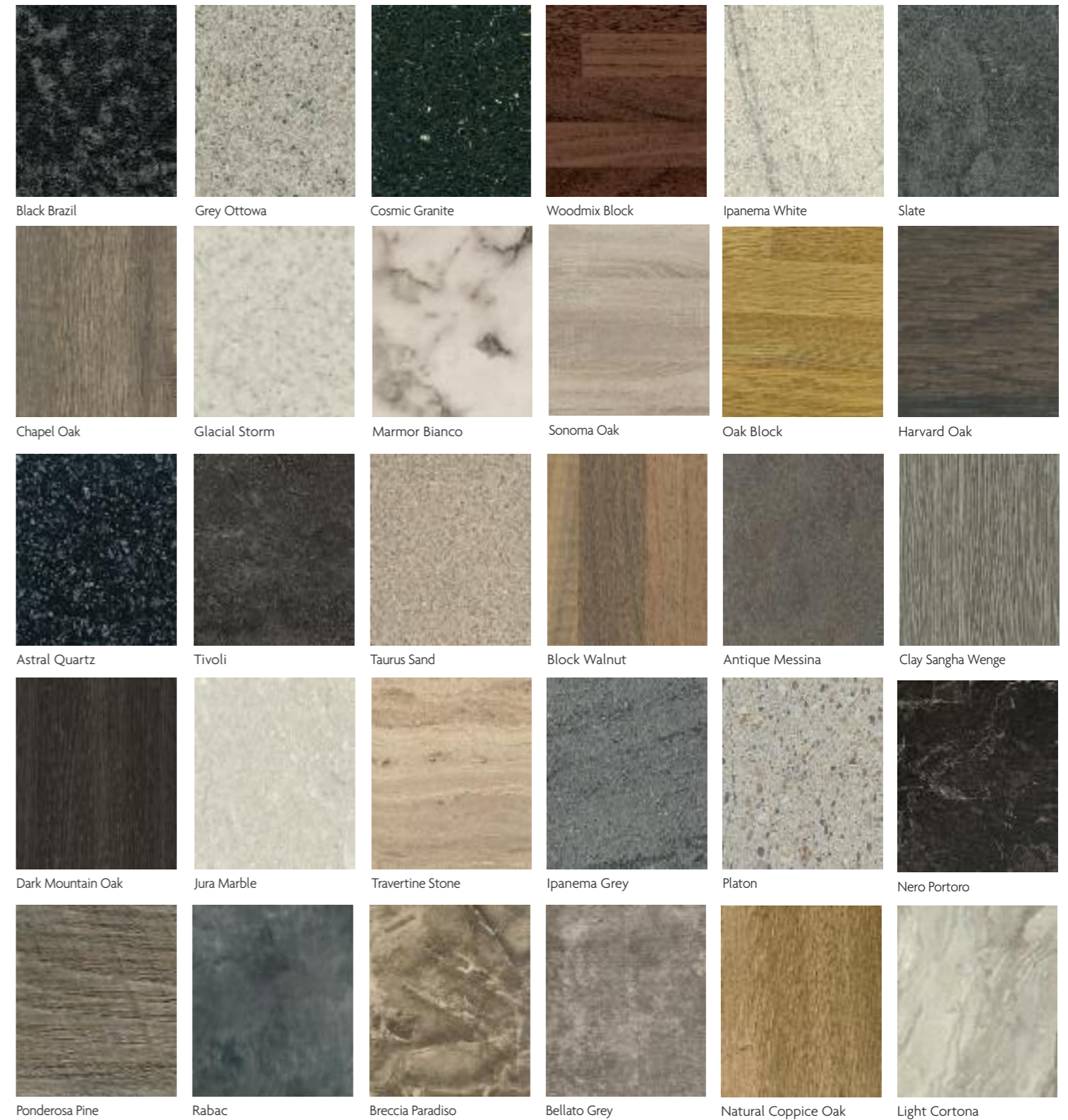

TOPSEAL & EASIBOLT - NEW LAMINATE WORKTOP INSTALLATION

Available in a choice of 13 colours to match our full range of 40mm thick Duropal worktops. The Topseal and Easibolt kit contains the following:

- x1 14ml of colour matched Topseal
- x1 Topseal applicator/scrapper
- x3 Worktop bolts & Easibolt holders
- x3 Quick leveling biscuits
- x1 20ml Acetone cleaner
- x1 Lint free cloth
- x1 Pair of disposable gloves



WORKTOP BOLT - 100mm bolt for use with 20mm thick tops. Please check jig position as cut-out differs from standard position.

BOLT152 - £5.00



£10.00 (See matrix for full list of codes and colours for each worktop)



WORKTOP - CONTINUOUS LENGTH (Quadra profile)
Please see the matrix on page 74 for availability by colour/material

40MM WORKTOPS						
	DESCRIPTION	CODE	DEPTH	WIDTH	MATT	TEXTURED
	Single post formed 2000mm	W600S200	40mm	600mm	£115	£138
		WN600S200	20mm	600mm	£138	
	Single post formed 3000mm	W600S300	40mm	600mm	£182	£218
		WN600S300	20mm	600mm	£218	
	Double post formed 2000mm	W670D200	40mm	670mm	£177	£213
		WN670D200	40mm	670mm	£213	
	Double post formed 4000mm	W670D400	40mm	670mm	£355	£426
		WN670D400	20mm	670mm	£426	
	Double post formed 2000mm	W900D200	40mm	900mm	£215	£258
		WN900D200	20mm	900mm	£258	
	Double post formed 2500mm	W900D250	40mm	900mm	£285	£342
		WN900D250	20mm	900mm	£342	
Worktop Laminate Edge		WPE40	4.1m x 40mm		£7	£8
		WPE20PE	4.1m x 20mm		£8	

LAMINATE BACKBOARDS & UPSTANDS							
	SIZE	CODE	WIDTH	MATT	ALUMINIUM	TEXTURED	
	13mm thick laminated both sides. Edged all round. Available in all colours (see above for codes). Also available in Aluminium (AL). Please check manufacturer's instructions before fitting behind a hob.	2000 x 640mm	SPLASH20X64(--)	600mm	£162	£297	£194
		4000 x 640mm	SPLASH40X64(--)	640mm	£324	£583	£389
		1550 x 600mm	SPLASH15X60(--)	600mm	£115	£212	£138
		1550 x 900mm	SPLASH15X90(--)	900mm	£172	£314	£206
		2000 x 100mm	SPLASH20X10(--)	100mm	£40	£77	£48
		4000 x 100mm	SPLASH40X10(--)	100mm	£80	£148	£96

WORKTOP EDGINGS

22 & 40MM GABLE ENDS							
	DESCRIPTION	CODE	DEPTH	WIDTH	MATT	TEXTURED	
	Edged 1.5mm Polypropylene Edging. Available in all colours (see matrix for codes).	To suit 600mm worktops 1000mm*	W596S100	40mm	596mm	£101	£121
			WN596S100	22mm	596mm	£121	
		To suit 670mm worktops 1000mm**	W662D100	40mm	662mm	£129	£155
			WN662D100	22mm	662mm	£155	
		To suit 670mm worktops 1550mm**	W662D155	40mm	662mm	£201	£241
			WN662D155	22mm	662mm	£241	
		To suit 900mm worktops 1000mm**	W892D100	40mm	892mm	£150	£180
			WN892D100	22mm	892mm	£180	

* For use at the end of a run of units
** For use on islands and peninsulars

CURVED LAMINATE WORKTOPS (Straight Edge Profile) - Please note we don't recommend mixing edge and quadra profile worktops.
Please see the matrix on page 74 for availability by colour/material

	DESCRIPTION	PRODUCT CODE	DEPTH	WIDTH	MATT	TEXTURED
	Curved Left Hand Edge 2000mm	W600CL200	40mm	600mm	£391	£469
		WN600CL200	22mm	600mm	£371	£446
	Curved Left Hand Edge 4000mm	W600CL400	40mm	600mm	£680	£816
		WN600CL400	22mm	600mm	£646	£775
	Curved Right Hand Edge 2000mm	W600CR200	40mm	600mm	£391	£469
		WN600CR200	22mm	600mm	£371	£446
	Curved Right Hand Edge 4000mm	W600CR400	40mm	600mm	£680	£816
		WN600CR400	22mm	600mm	£646	£775
	Double Curved, Edged All Round 2000mm	W680CD200	40mm	680mm	£644	£773
		WN680CD200	22mm	680mm	£612	£735
	Double Curved, Edged All Round 4000mm	W680CD400	40mm	680mm	£1,072	£1,287
		WN680CD400	22mm	680mm	£1,019	£1,223
	Double Curved, Edged All Round 1500mm	W940CD150	40mm	940mm	£697	£837
		WN940CD150	22mm	940mm	£662	£795
	Double Curved, Edged All Round 2500mm	W940CD250	40mm	940mm	£1,018	£1,221
		WN940CD250	22mm	940mm	£967	£1,160
	Curved on Four Corners, Edged All Round 1280mm	W680IS128	40mm	680mm	£743	£892
		WN680IS128	22mm	680mm	£706	£847
	Curved on Four Corners, Edged All Round 1580mm	W680IS158	40mm	680mm	£816	£979
		WN680IS158	22mm	680mm	£775	£930
	Curved on Four Corners, Edged All Round 1880mm	W680IS188	40mm	680mm	£888	£1,066
		WN680IS188	22mm	680mm	£844	£1,013
	Curved on Four Corners, Edged All Round 2480mm	W680IS248	40mm	680mm	£1,034	£1,241
		WN680IS248	22mm	680mm	£982	£1,179
	Curved on Four Corners, Edged All Round 1280mm	W940IS128	40mm	940mm	£876	£1,051
		WN940IS128	22mm	940mm	£832	£999
	Curved on Four Corners, Edged All Round 1580mm	W940IS158	40mm	940mm	£980	£1,176
		WN940IS158	22mm	940mm	£931	£1,117
	Curved on Four Corners, Edged All Round 1880mm	W940IS188	40mm	940mm	£1,084	£1,301
		WN940IS188	22mm	940mm	£1,030	£1,235
	Curved on Four Corners, Edged All Round 2480mm	W940IS248	40mm	940mm	£1,292	£1,550
		WN940IS248	22mm	940mm	£1,227	£1,472
	For use with Internal Curved Corner Unit 980mm Edged on curved edge - Logica/Fusion	W980C	40mm	980mm	£457	£549
		WN980C	22mm	980mm	£435	£521
		W980C2*	40mm	980mm	£457	£549
		WN980C2*	22mm	980mm	£435	£521
		* For use with Shaker/Opaco				
Worktop polypropylene edging		WE40P	4.1m x 40mm x 1.5mm		£17	£20
		WE22P	4.1m x 22mm x 1.5mm		£16	£19



CURVED LAMINATE WORKTOPS (Straight Edge Profile) - Please note we don't recommend mixing edge and quadra profile worktops.

Please see the matrix on page 74 for availability by colour/material

DESCRIPTION	PRODUCT CODE	DEPTH	WIDTH	MATT	TEXTURED
Straight Length - Edged on Front & Ends 1000mm	W600E100	40mm	600mm	£214	£257
	WN600E100	22mm	600mm	£204	£245
Straight Length - Edged on Front & Ends 2000mm	W600E200	40mm	600mm	£345	£414
	WN600E200	22mm	600mm	£328	£394
Straight Length - Edged on Front & Ends 4000mm	W600E400	40mm	600mm	£617	£740
	WN600E400	22mm	600mm	£586	£703
Straight Length - Edged all round 2000mm	W640DE200	40mm	640mm	£427	£512
	WN640DE200	22mm	640mm	£405	£486
Straight Length - Edged all round 4000mm	W640DE400	40mm	640mm	£775	£930
	WN640DE400	22mm	640mm	£737	£884
Straight Length - Edged all round 2000mm	W680DE200	40mm	680mm	£519	£623
	WN680DE200	22mm	680mm	£493	£592
Straight Length - Edged all round 4000mm	W680DE400	40mm	680mm	£1,038	£1,245
	WN680DE400	22mm	680mm	£986	£1,183
Straight Length - Edged all round 1500mm	W940DE150	40mm	940mm	£605	£726
	WN940DE150	22mm	940mm	£575	£690
Straight Length - Edged all round 2500mm	W940DE250	40mm	940mm	£951	£1,141
	WN940DE250	22mm	940mm	£903	£1,084
Straight Laminate Gable End with 1.5mm Polypropylene Edging - 1000mm	W598SE100	40mm	598mm	£101	£121
	WN598SE100	22mm	598mm	£96	£115
Straight Laminate Gable End with 1.5mm Polypropylene Edging - 1000mm	W636DE100	40mm	636mm	£129	£155
	WN636DE100	22mm	636mm	£123	£148
Straight Laminate Gable End with 1.5mm Polypropylene Edging - 1550mm	W636DE155	40mm	636mm	£201	£241
	WN636DE155	22mm	636mm	£191	£229
Straight Laminate Gable End with 1.5mm Polypropylene Edging - 1000mm	W676DE100	40mm	676mm	£150	£180
	WN676DE100	22mm	676mm	£142	£171
Straight Laminate Gable End with 1.5mm Polypropylene Edging - 1550mm	W676DE155	40mm	676mm	£231	£277
	WN676DE155	22mm	676mm	£219	£263
Straight Laminate Gable End with 1.5mm Polypropylene Edging - 1000mm	W936DE100	40mm	936mm	£210	£252
	WN936DE100	22mm	936mm	£200	£240
Polypropylene Edging (4m x 1.5mm)	WE40P	40mm		£17	£20
Polypropylene Edging (4m x 1.5mm)	WE22P	22mm		£16	£19

COLOUR CO-ORDINATED CABINETS

Cabinets are made from 18mm thick Melamine Faced Chipboard (MFC) panels incorporating solid backs. You can choose from 11 colour co-ordinating finishes which feature on both interior and exterior surfaces.

You can choose any cabinet colour to co-ordinate your chosen fascia.

10 YEAR GUARANTEE*
FOR ALL ENGLISH ROSE CABINETS

*Please ask your retailer for further details

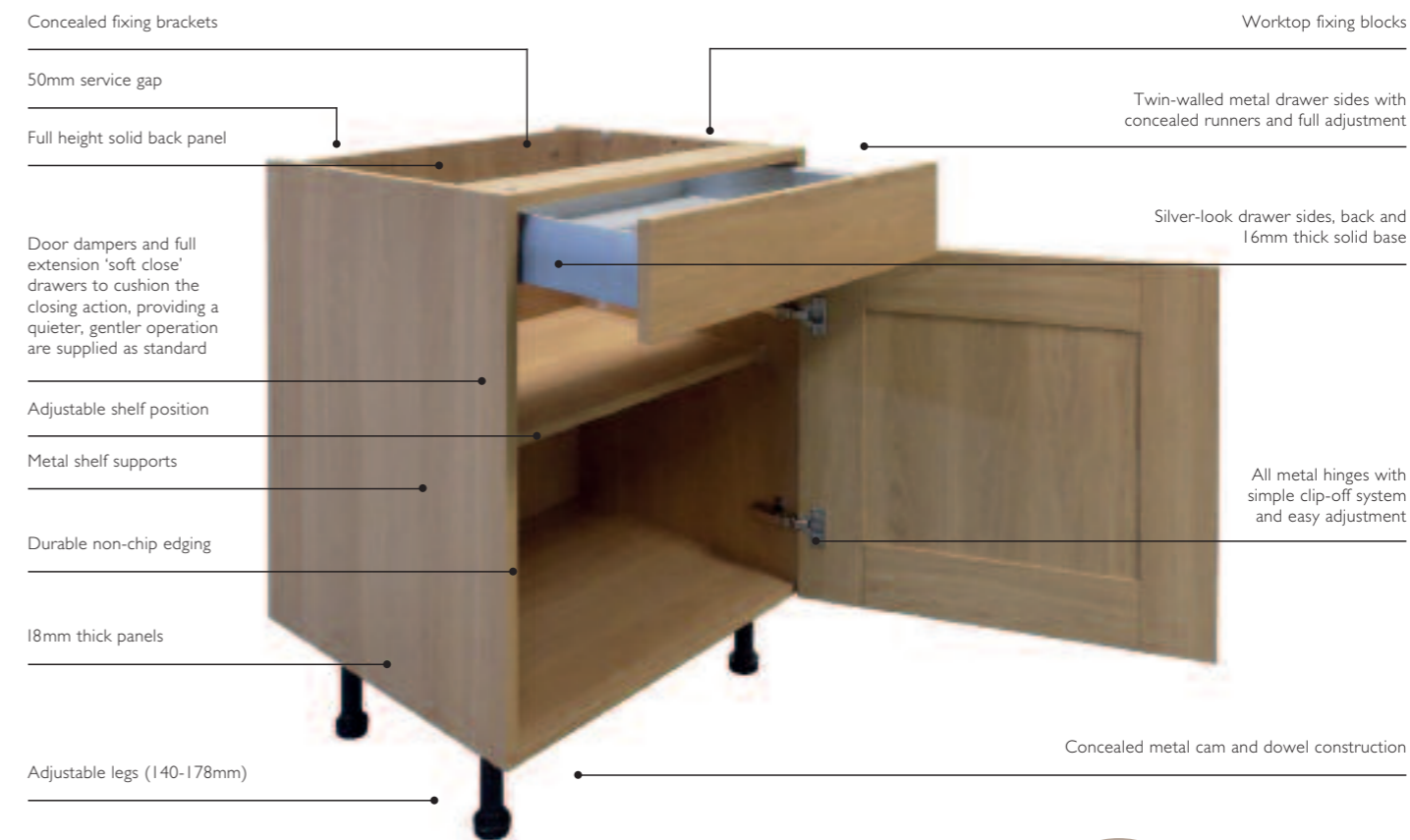

CABINET FEATURES



English Rose cabinets are available with an oak drawer upgrade - see page 72.

DRAWERS

English Rose Kitchens are supplied with dampers and full extension metal runners as standard. Full extension allows the drawer to open to its full depth for easier access.

SPECIAL WORKTOP PLANNING GUIDELINES

Planning Details for Curved Units

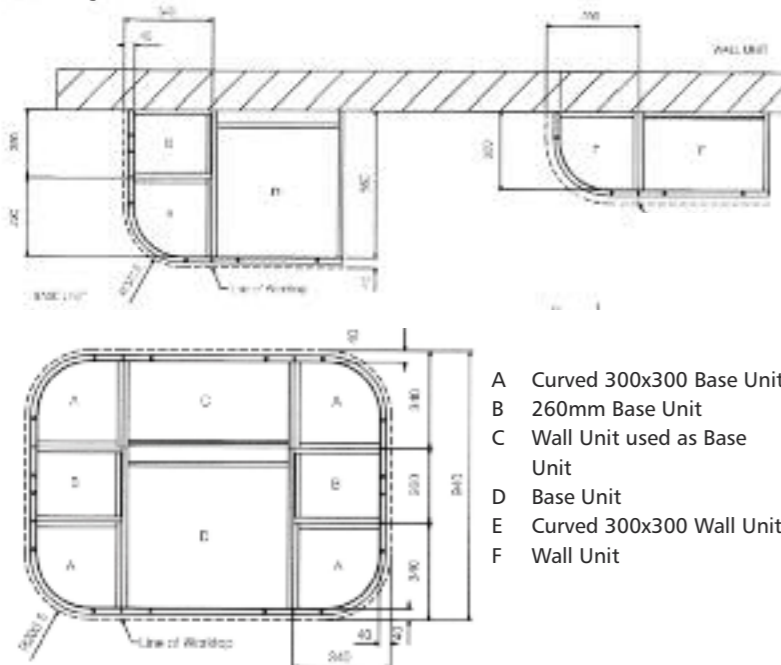

Internal Curved Corner Units

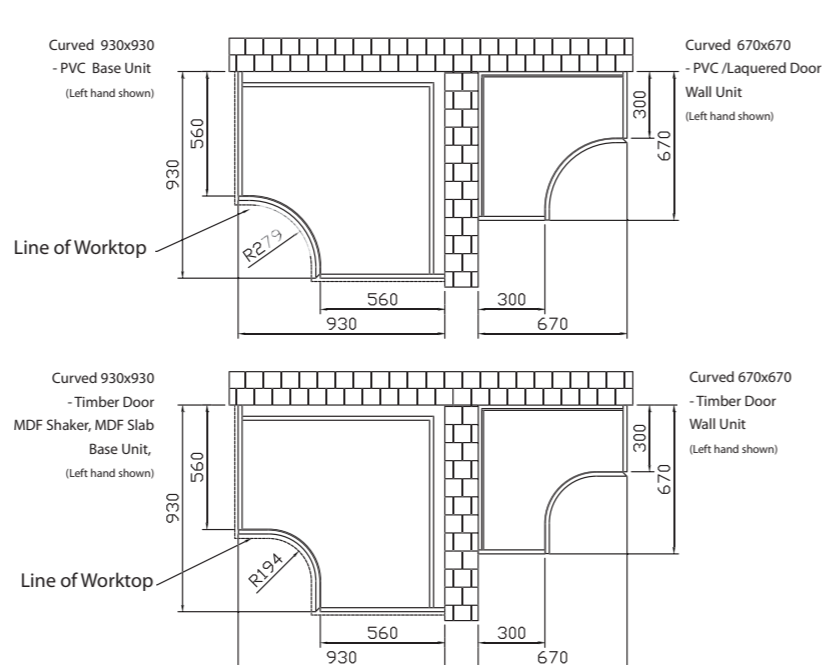



ENGLISH ROSE 'CONTACT' - HANDLE-LESS KITCHENS



The English Rose 'Contact' system is designed to make the planning and installation of a handleless kitchen as simple and straightforward as possible. Some basic principles are covered in this technical section and a full installation and adjustment leaflet will be supplied with each English Rose 'Contact' kitchen.

The principle of 'Contact' is that wherever possible, doors and flaps are opened simply by touch which will activate the opening mechanism.

(Please note that certain appliance doors, pull-out units, magic corner units, etc are not available with this touch open system. The following pages will demonstrate the various options for designing a 'Contact' kitchen with these units).

In the same way, 'Contact' drawers and pan drawers are opened by simply pressing on the drawer to activate the spring open runners.

(Please note that certain drawers used on pull-out units are not available with spring open drawer runners. Internal drawers are not available with spring open runners).

A surcharge of £45 per drawer applies. Units that are affected by this are identified in the Price List by ★.

You will automatically receive the full quantity of 'contact' mechanisms to match your order. Additional 'Contact' mechanisms can also be purchased, please refer to page 66.

English Rose 'Contact' is available on all Contemporary, Zest, Opaco Painted and Logica doors. Also available in White Satin.

Please ensure you specify 'Contact' on your order.



Handle Options For Appliance Housings/Fascias, Pull-Out Units and Magic Corner Units

Any units that require a handle, such as appliance housings, appliance fascias, pull-out units and magic corner units, are clearly marked in the Price List with the following symbols:

- ❖ Select from handle suite 653 (for use with aluminium extrusions) or face fixed handle suite 609
- ◆ Select from face fixed handle suite 609
- ▲ When using the aluminium extrusion under the worktops, the conventional corner unit must use a variable corner post. The post will be supplied in the form of a 716 x 146mm fascia and will require cutting to fit on site. *Please add 'CN' to the end of the code to order in 'Contact'.*

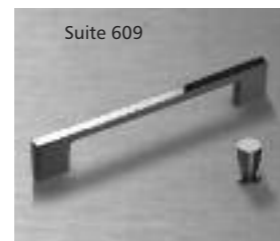

Suite 653 has been specifically designed to work with 'Contact' kitchens when aluminium extrusions are used.

This handle can be fitted simply, on-site, and enables the individual to pull open the units specified above, whilst not intruding on the handlefree design.

Option 1 - Free-Standing Appliances

The simplest way of designing a Contact kitchen is to use free-standing appliances whilst avoiding certain units – e.g. pull-out units, magic corners, etc. Any unit that requires a handle will be clearly identified within the Price list.

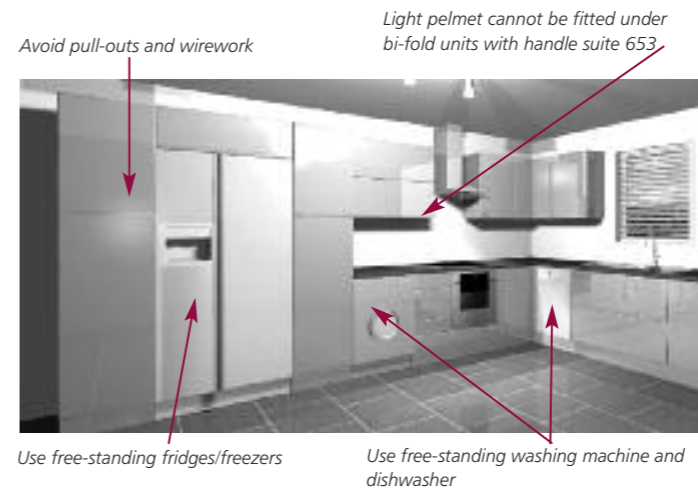

Option 2 - Integrated Appliances

The second way of designing a Contact kitchen is to order certain appliance doors and units with a face fixed handle. These are highlighted in the Price list and recommended handle suite is 609.

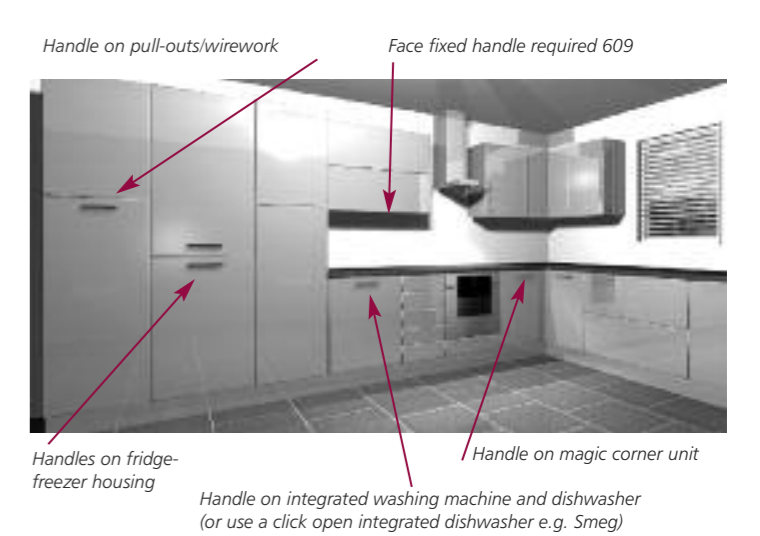

Option 3 - Aluminium Extrusion

The third way of designing a Contact kitchen is to fit worktop extrusion to the base units which lifts the worktop by 30mm. 30mm vertical extrusions are used between tall units. Certain appliance doors and units need to be ordered with handle Suite 653 with the extrusions providing a recess which allows access to the handle.

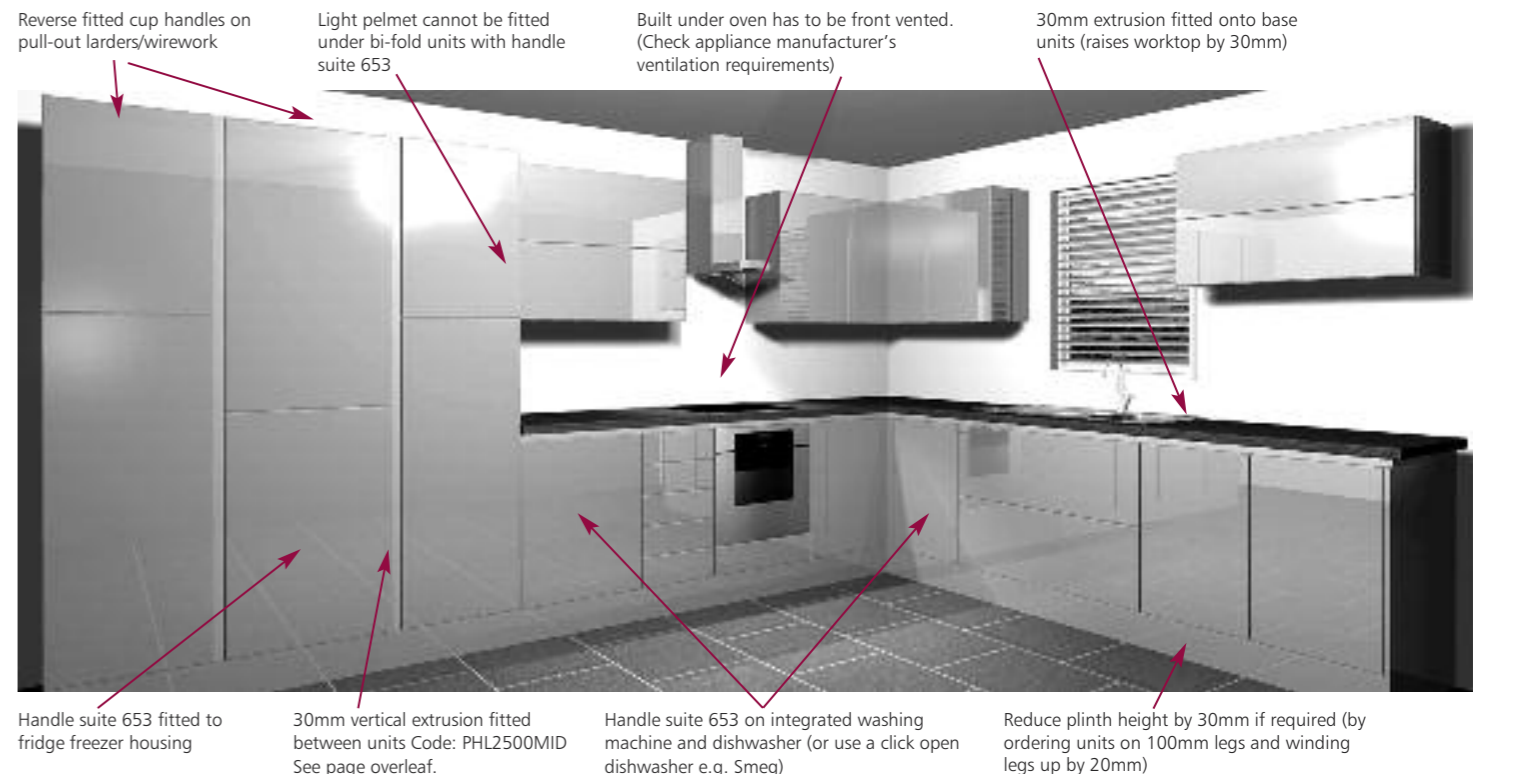

Aluminium extrusion fitted horizontally below worktop Code: PHL3500WEK. See page overleaf.

Built under ovens should be front vented (check appliance manufacturers ventilation requirements).

The built under oven aperture is H582 x W563mm (for taller ovens cut away the aluminium extrusion as required).



Suite 653 – Units that require this handle are marked with ❖

PLEASE NOTE THE WORKTOP EXTRUSION CANNOT BE USED WITH CURVED UNITS.

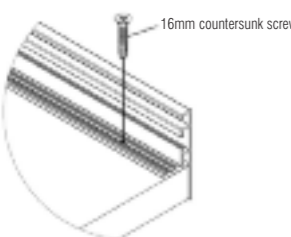
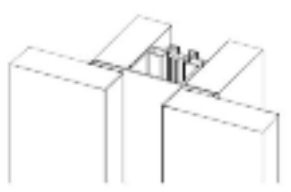
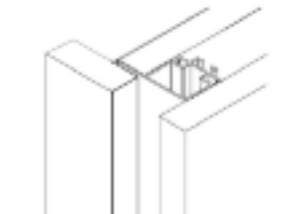
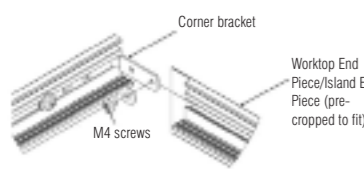
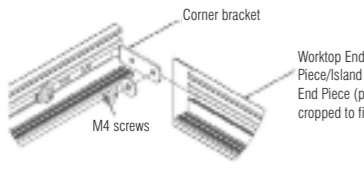
Contact Worktop Extrusion Kit	PHL3500WEK £70
	Extrusion 3500mm (stainless steel finish) x 1 Plastic spacer blocks x 12 Extrusion fixing screws (16mm countersunk) x 10 Spacer fixing screws (20mm countersunk) x 24 Straight extrusion connector plate x 1 Internal/external extrusion corner bracket & screws x 2
Vertical Mid Extrusion Kit	PHL2500MID £70
	Extrusion 2500mm (stainless steel finish) x 1 Plastic fixing block x 6 Plastic spacer block x 6 Fixing block/spacer fixing screws (20mm countersunk) x 12 Connecting screws (60mm countersunk) x 6 Self tapping screws (25mm countersunk) x 6
Vertical End Extrusion Kit	PHL2300END £70
	Extrusion 2300mm (stainless steel finish) x 1 Plastic fixing block x 6 Plastic spacer block x 6 Fixing block/spacer fixing screws (20mm countersunk) x 12 Connecting screws (60mm countersunk) x 6 Self tapping screws (25mm countersunk) x 6
Worktop/Small Island Worktop End Kit	PHL558ISL £22
	To suit a 636mm wide Island worktop using a 716 x 596 door as an Island end panel Extrusion 558mm cropped both ends (stainless steel finish) x 1 Internal/external extrusion corner bracket & screws x 2 Extrusion fixing screws (16mm countersunk) x 3
Worktop/Large Island Worktop End Kit	PHL822ISL £26
	To suit a 900mm wide Island worktop using a 716 x 860 Island end panel Cut one end to use as a worktop end of run extrusion Extrusion 822mm cropped both ends (stainless steel finish) x 1 Internal/external extrusion corner bracket & screws x 2 Extrusion fixing screws (16mm countersunk) x 4

Contact Drawer Runners

To adjust the gap between the drawer front and the front of the carcass, use a coin to turn the adjustment screw at the back of the runner.
A gap of approximately 4mm is required to activate the 'Contact' mechanism.

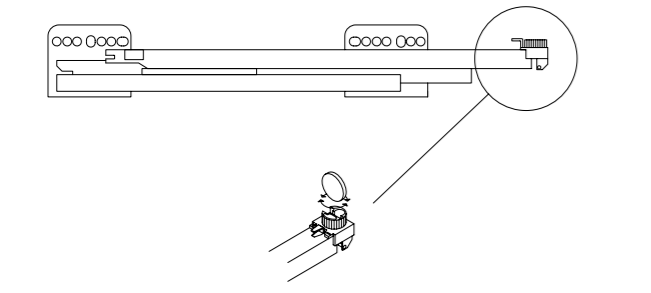

Contact Worktop Extrusion Fixing

A worktop extrusion is fitted on site. This extrusion raises the worktop by 30mm giving a unit height excluding worktop of 900mm. The plinth height can be reduced by 30mm if required (by ordering the units on 100mm legs and winding them up by 20mm, and cutting the plinths down by 30mm).
For front vented built under ovens please check the appliance manufacturer's ventilation requirements.
The worktop extrusion kit includes all the fixing screws, spacer blocks and extrusion corner and straight connectors required.
Note: Granite and solid surface worktops can be bonded to 30mm MDF spacer battens instead of the spacer blocks, or two thicknesses of 15mm MFC could be used.

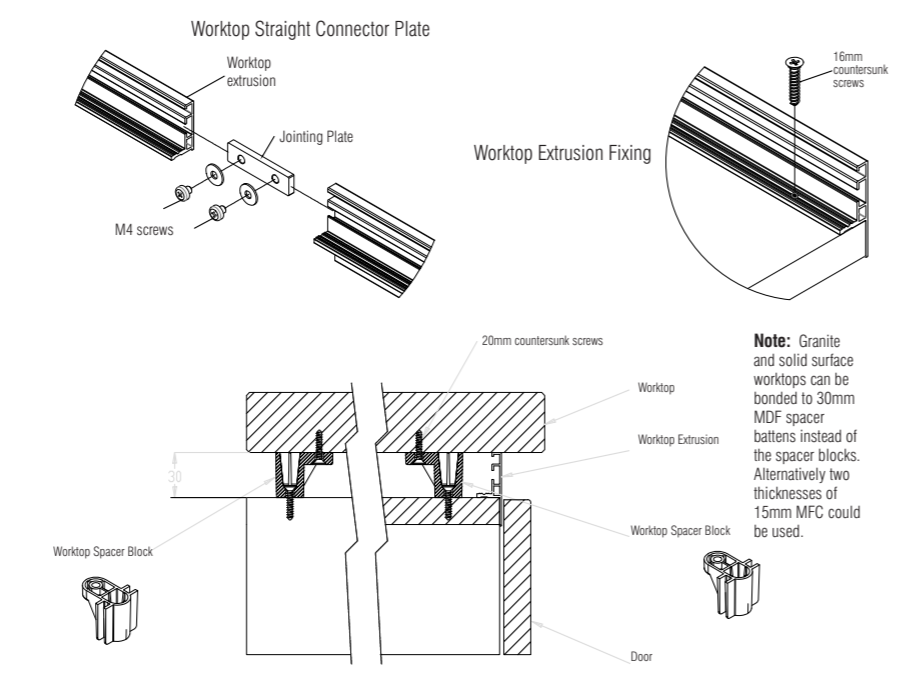

Contact Worktop Extrusion Corner Jointing

Between Euro Units, Larders and Oven Housings:
A vertical mid extrusion is fitted on site. This extrusion spaces the units apart by 30mm. The vertical mid extrusion kit includes all the fixing screws, fixing blocks and spacer blocks required.

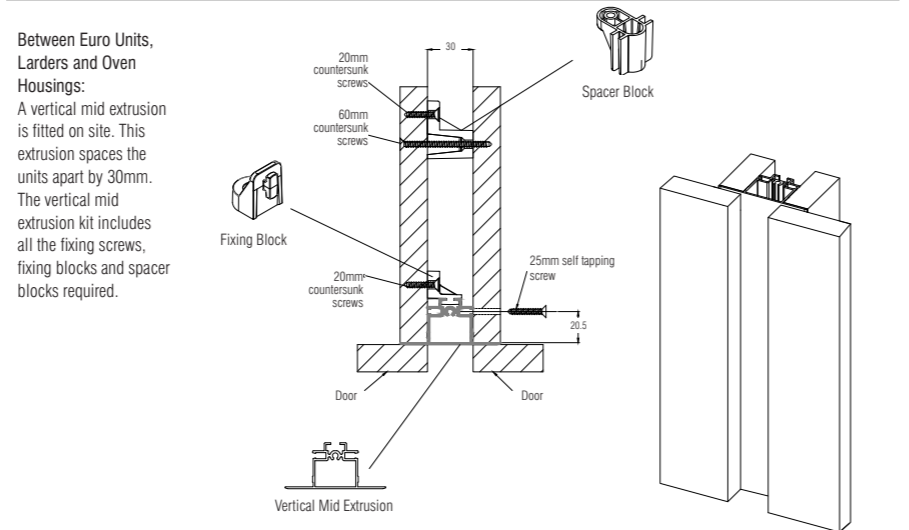

At the end of a run of Euro Units, Larders and Oven Housing:

A vertical end extrusion is fitted on site if required. The vertical end extrusion kit includes all the fixing screws, fixing blocks and spacer blocks required.

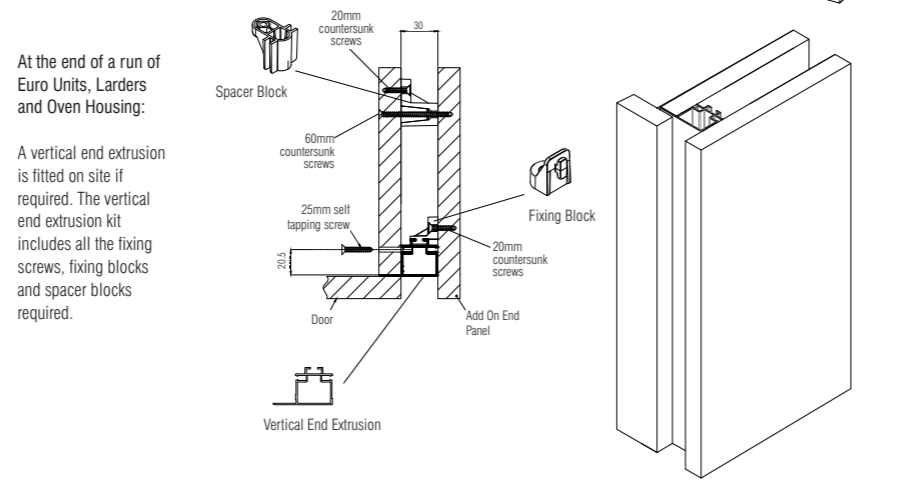



TECHNICAL SPECIFICATIONS

STANDARD HEIGHT BASE & WALL UNITS

BEFORE ORDERING PLEASE NOTE:

75% of all kitchens ordered have insufficient quantities of plinth, cornice/pelmet and accessory panels.

Please double check your requirements allowing sufficient extra lengths to cover joints, mitres, shapings etc. Failure to do so may delay your installation.

KEY

(!) = CHECK UNIT AVAILABILITY IN PRICING SECTION

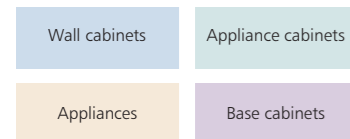

NOTE:

Measurements are in millimetres.

Not all units shown are available in every range.

Inside stacked wall units and bridging units under cupboard lights should be used instead of low voltage downlights.

J-profile doors are drilled for hinges on both sides to allow for either a left or right hand opening position.

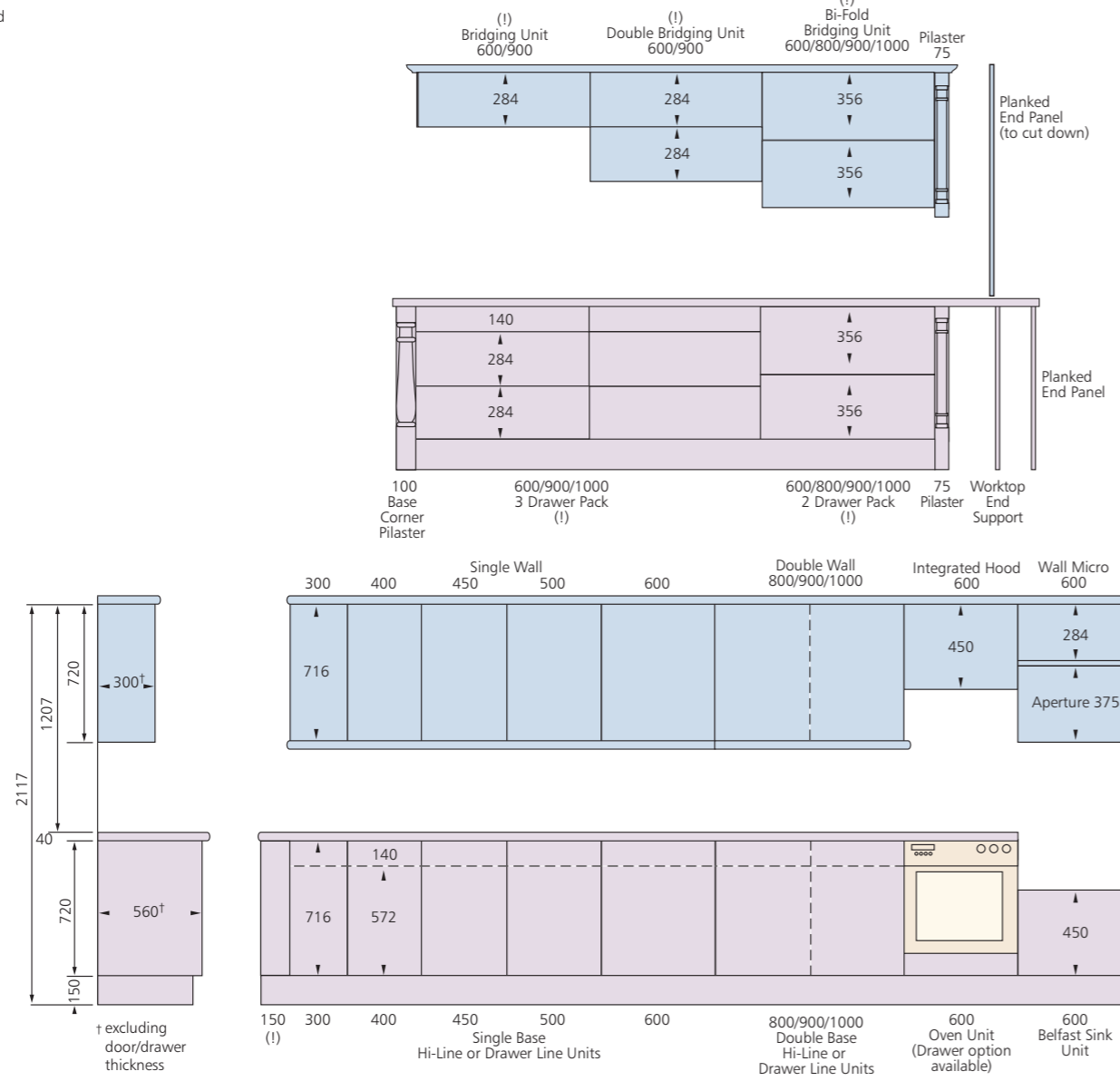
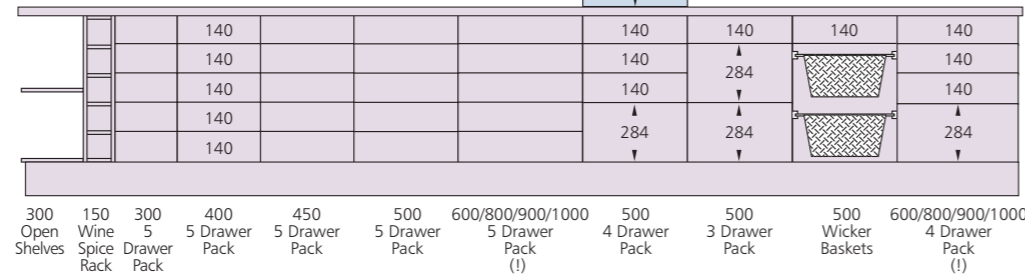
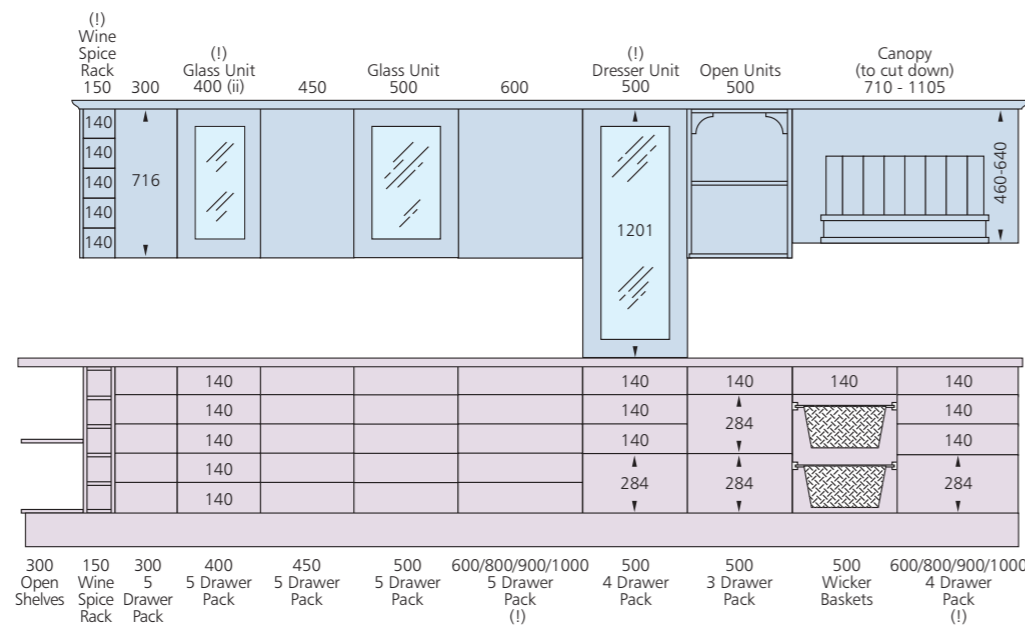

TALL BASE & WALL UNITS (Please refer to the At a Glance pages for details of tall unit availability)

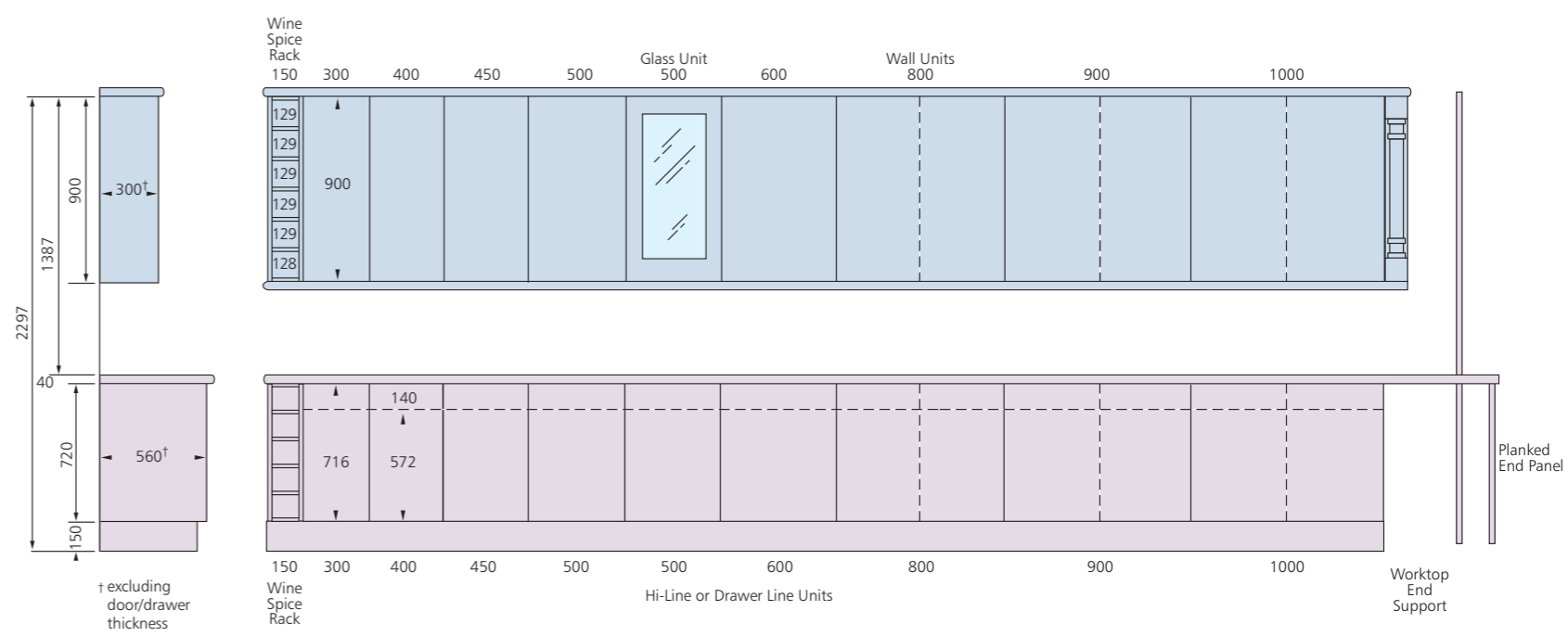

Corner Units

If your new kitchen plan includes a corner unit this should always be fitted first. Please note the corner unit positioning and spacing in the guide shown right.

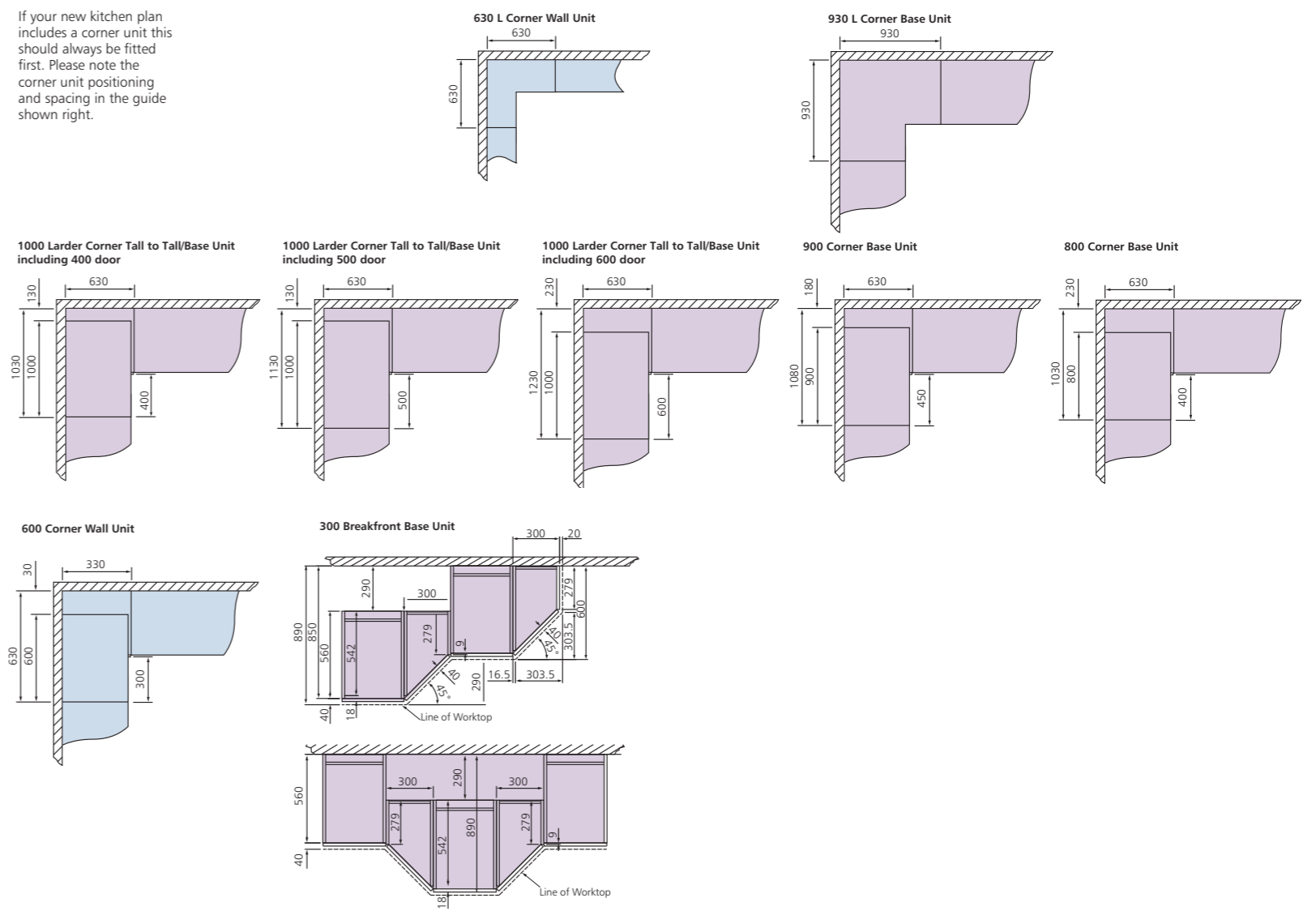

GEORGE CLARKE
ENGLISH ROSE BRAND AMBASSADOR



ENGLISH ROSE®

DESIGNED FOR LIVING

PART OF



OMEGA PLC

THE VERY BRITISH COLLECTION



For further information please contact:

The Customer Service Department, English Rose Kitchens, Omega Boulevard, Capitol Park, Thorne, Doncaster DN8 5TX

Tel: 01405 743332 | Fax: 01405 743330 | erkitchens.co.uk

In the interest of product development we reserve the right to change colours, specifications and design without prior notice and without incurring obligation.

E. & O.E. All prices include VAT.